



DATASHEET

VGC10

v1.4

1. Datasheet

1.1. VGC10

General Properties		Minimum	Typical	Maximum	Unit
Vacuum		5 %	-	80 %	[Vacuum]
		-0.05	-	-0.810	[Bar]
		1.5	-	24	[inHg]
Air flow		0	-	12	[L/min]
Payload	With default attachments	-	-	6 *	[kg]
		-	-	13.2 *	[lb]
	With customized attachments	-	10	15	[kg]
		-	20	33.1	[lb]
Vacuum cups		1	-	7	[pcs.]
Gripping time		-	0.35	-	[s]
Releasing time		-	0.20	-	[s]
Vacuum pump		Integrated, electric BLDC			
Dust filters		Integrated 50µm, field replaceable			
IP Classification		IP54			
Dimensions		101 x 100 x 100			[mm]
		3.97 x 3.94 x 3.94			[inch]
Weight		0.814			[kg]
		1.79			[lb]

* By using three 40mm cups. More info in the table [Number of Cups needed for non-porous materials depending on payload and vacuum.](#)

Operating Conditions	Minimum	Typical	Maximum	Unit
Power supply	20.4	24	28.8	[V]
Current consumption	50	600	1500	[mA]
Operating temperature (gripper and vacuum cups)	0	-	50	[°C]
	32	-	122	[°F]
Relative humidity (non-condensing)	0	-	95	[%]
Calculated operation life	30 000	-	-	[Hours]

2 Channels

The VGC10 has 4 holes to use fittings with vacuum cups or blinding screws as needed. It also has lines which show the holes that are communicated together. This is useful when using channels A and B independently for vacuum.

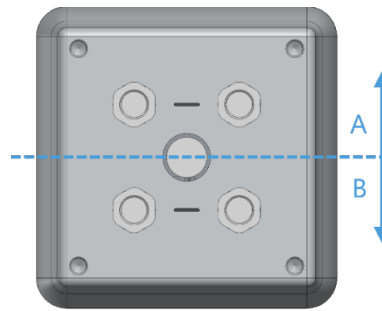
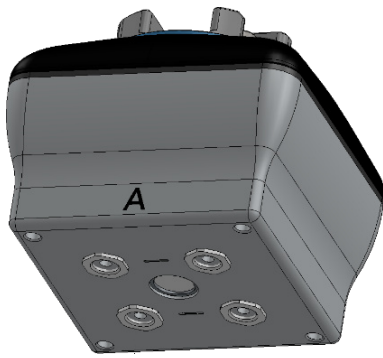

Adaptor Plate

The VGC10 comes with an Adaptor Plate which provides extra flexibility to locate the vacuum cups in different configurations.

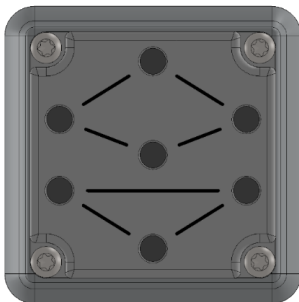

The Adaptor Plate has 7 holes to use fittings with vacuum cups or blinding screws as needed. It also has lines which show the holes that are communicated together. This is useful when using channel A and B independently for vacuum.

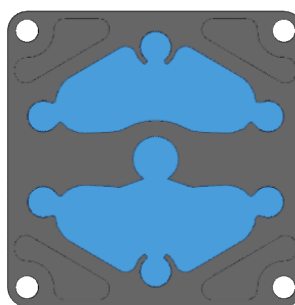
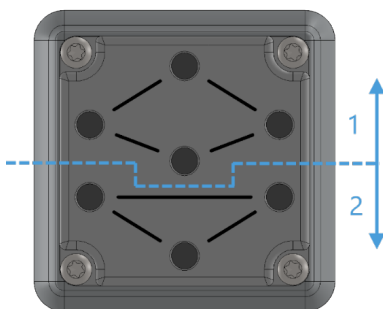

The Adaptor Plate can be placed in different positions by rotating it 90°. Having as reference the letters A and B written on the gripper housing, the Adaptor Plate can be placed to separate both channels or to communicate them. If the Adaptor Plate is placed as in picture below on the left, both channels will be separated, and they can be used independently or combined. If the Adaptor Plate is placed as in picture below on the right, both channels will be communicated and a higher air flow can be achieved, although both channels will have to be used combined.

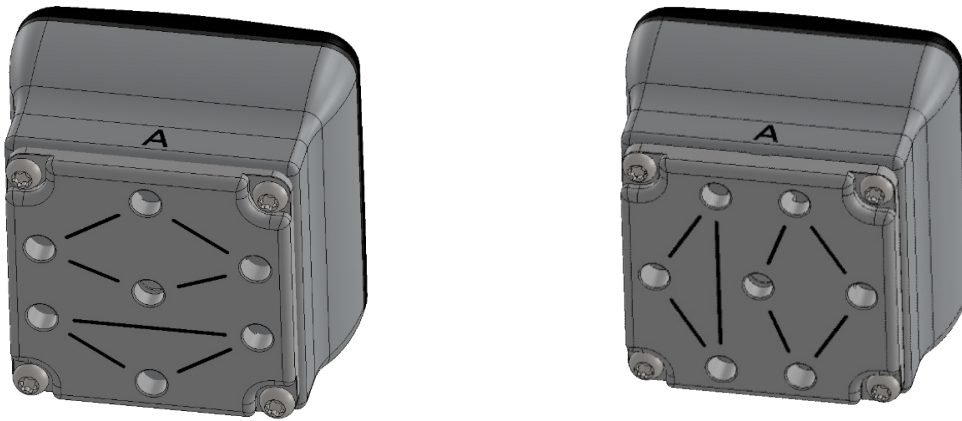

To mount the Adaptor Plate simply remove the 4 fittings or blinding screws from the gripper, place the Adaptor Plate by choosing the right angle according to the desired configuration, and tighten the 4 screws with 4 Nm tighten torque.

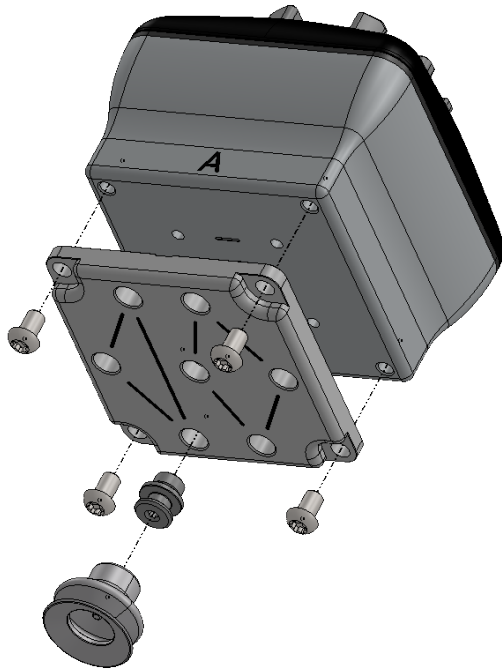
**NOTE:**

Please, note that the O-Ring in the Adaptor Plate is not glued therefore it can be pulled out. If that happens simply put it back in place and the gripper will work as before.

Extension Pipe

The Extension Pipe provides an extra length of 50 mm to reach narrow spaces.

**NOTE:**

Remember to use the Adaptor Plate rotated to achieve a higher air flow when using both channels together.

The Extension Pipe can be mounted in any of the holes by simply screwing it in and adding a fitting on top as shown in the image below.



Below different mounting configurations with the provided attachments are shown.

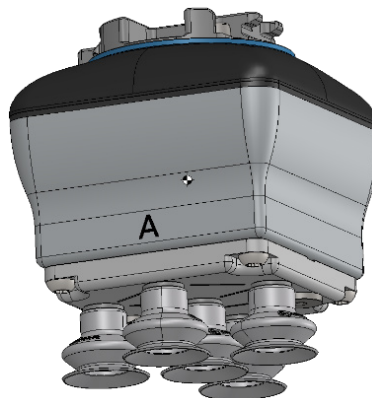
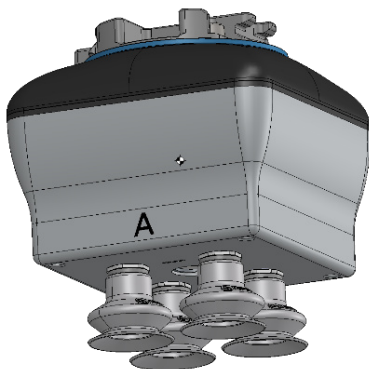

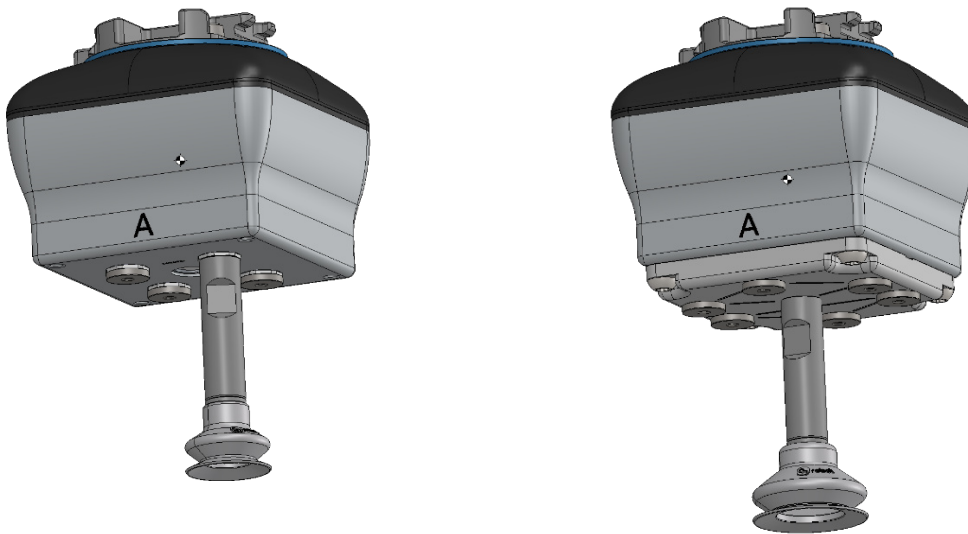

Customized Adaptor Plates and Push-in Fittings

The design of the VGC10 is meant to facilitate the users to make their own adaptor plates to create different kinds of configurations. The dimensions needed to create a customized adaptor plate are shown in the image below.

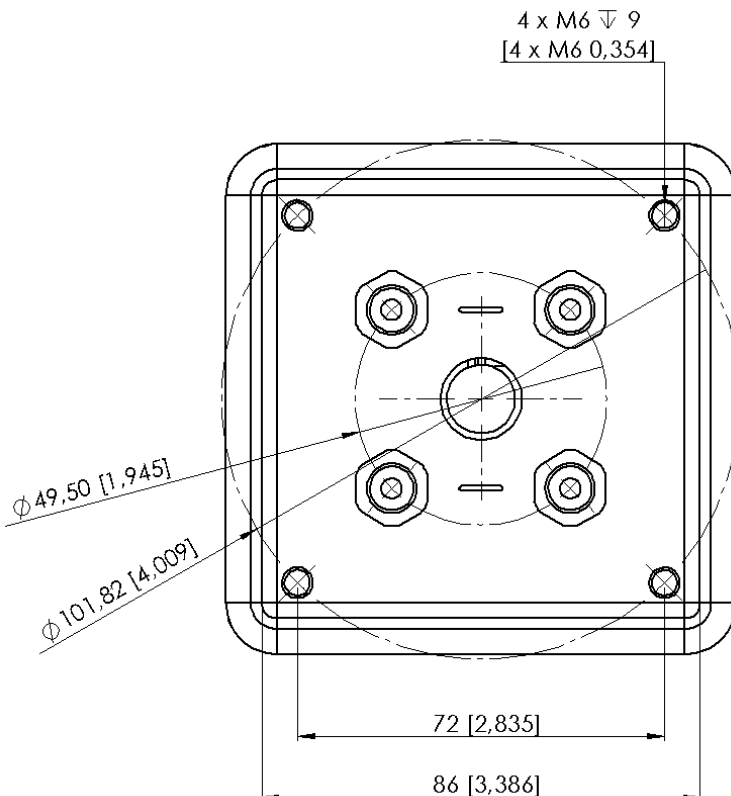

The Push-in Fittings are used to attach 4 mm vacuum tubes to create customized configuration that required remote vacuum. In most cases, this size is enough for generating the needed vacuum from the pump in the gripper.

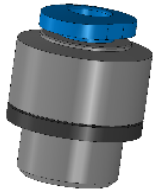

The commercial name of the Push-in Fittings is Fitting QSM-G1/8-4-I-R in case some more units need to be purchased.

An example of a customized configuration with a homemade adaptor plate and remote vacuum is shown below.

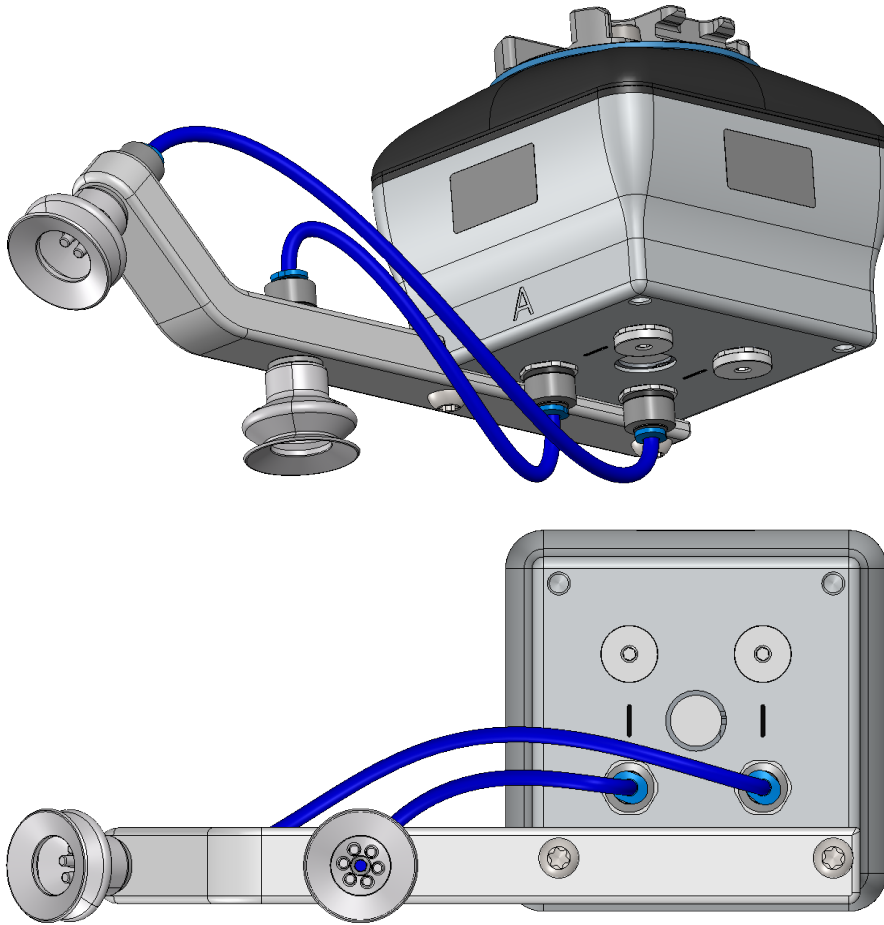

The image below shows how the push-in fittings and the normal fittings are communicated.

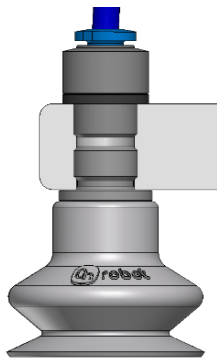



Payload

The lifting capacity of the VG grippers depends primarily on the following parameters:

- Vacuum cups
- Vacuum
- Air flow

Vacuum Cups

Choosing the right vacuum cups for your application is essential. The VG grippers come with common 15, 30 and 40 mm silicone vacuum cups (see table below) which are good for hard and flat surfaces, but not good for uneven surfaces and it might leave microscopic traces of silicone on the workpiece which can cause issues with some types of painting processes afterwards.



Image	External Diameter [mm]	Internal Diameter [mm]	Gripping Area [mm ²]
	15	6	29
	30	16	200
	40	24	450

For non-porous materials, the OnRobot suction cups are highly recommended. Some of the most common non-porous materials are listed below:

- Composites
- Glass
- High density cardboard
- High density paper
- Metals
- Plastic
- Porous materials with a sealed surface
- Varnished wood

In an ideal case, working with non-porous material workpieces where there are no air flow going through the workpiece, the table below shows the number of cups and the cup size needed depending on the payload (workpiece mass) and the vacuum used.

Number of Cups needed for non-porous materials depending on payload and vacuum :

	 15 mm				 30 mm				 40 mm			
Payload (kg)	Vacuum (kPa)				Vacuum (kPa)				Vacuum (kPa)			
	20	40	60	75	20	40	60	75	20	40	60	75
0.1	3	2	1	1	1	1	1	1	1	1	1	1
0.5	13	7	5	4	2	1	1	1	1	1	1	1
1	-	13	9	7	4	2	2	1	2	1	1	1
2	-	-	-	14	8	4	3	2	4	2	2	1
3	-	-	-	-	12	6	4	3	5	3	2	2
4	-	-	-	-	15	8	5	4	7	4	3	2
5	-	-	-	-	-	10	7	5	9	5	3	3
6	-	-	-	-	-	12	8	6	10	5	4	3
7	-	-	-	-	-	13	9	7	12	6	4	4
8	-	-	-	-	-	15	10	8	14	7	5	4
9	-	-	-	-	-	-	12	9	15	8	5	4
10	-	-	-	-	-	-	13	10	-	9	6	5
11	-	-	-	-	-	-	14	11	-	9	6	5
12	-	-	-	-	-	-	15	12	-	10	7	6
13	-	-	-	-	-	-	16	13	-	11	8	6
14	-	-	-	-	-	-	-	14	-	12	8	7
15	-	-	-	-	-	-	-	15	-	13	9	7



NOTE:

To use more than 7 (15mm), 4 (30mm) or 3 (40mm) vacuum cups with the VGC10 a customized adaptor plate is needed.

The table above is created with the following formula that equalizes the lifting force with the payload considering 1.5G of acceleration.

$$\text{Amount}_{\text{Cups}} * \text{Area}_{\text{Cup}}[\text{mm}] = 14700 \frac{\text{Payload} [\text{kg}]}{\text{Vacuum} [\text{kPa}]}$$

It is often a good idea to use more vacuum cups than needed, to accommodate for vibrations, leaks and other unexpected conditions. However, the more vacuum cups, the more air leakage (air flow) is expected and the more air is moved in a grip resulting in longer gripping times.

When using porous materials, the vacuum that can be achieved by using the OnRobot suction cups will depend on the material itself and will be between the range stated in the specifications. Some of the most common non-porous materials are listed below:

- Fabrics
- Foam
- Foam with open cells
- Low density cardboard
- Low density paper
- Perforated materials
- Untreated wood

See the table below with general recommendations, in case other suction cups are needed for specific materials.

Workpiece surface	Vacuum cup shape	Vacuum cup material
Hard and flat	Normal or dual lip	Silicone or NBR
Soft plastic or plastic bag	Special plastic bag type	Special plastic bag type
Hard but curved or uneven	Thin dual lip	Silicone or soft NBR
To be painted afterwards	Any type	NBR only
Varying heights	1.5 or more bevels	Any type



NOTE:

It is recommended to consult a vacuum cup specialist to find the optimal vacuum cup where the standard types are insufficient.

Suction Cups for Foil and Bags Ø25

This suction cup improves the vacuum gripper’s ability to pick and place workpieces with surface of foil, thin paper, and plastic bags during irregular and angular arm movement.

	 25 mm			
Number of Cups	1	2	3	4
Surface	kg			
Foil	0.83	1.07	1.43	1.57
Thin paper	1.08	1.71	2.23	3.21
Foil - round shape	1.28	2.32	3.32	4.25
Plastic bag	0.32	0.54	0.63	0.74

The vacuum cup is silicone rubber compliant with the USA Food and Drug Administration (FDA).

Using this vacuum cup reduces the wrinkles made on thin workpieces (film, vinyl, and so on)

during absorption: 

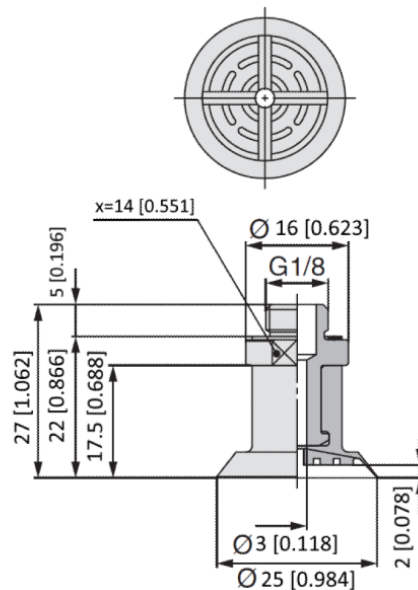

This vacuum cup is an accessory and need to be purchased separately. To purchase the vacuum cup, contact the vendor from where the VGx gripper has been purchased.

- Suction Cups for foil and bags Ø25 - PN 106964

Fittings and Blind Screws

It is possible to change suction cups simply by pulling them off the fittings. It might be a bit challenging to remove the 15 mm Diameter vacuum cups. As suggestion try to stretch the silicon to one of the sides and then pull it out.

Unused holes can be blinded using a blind screw, and each fitting can be changed to a different type to match the desired suction cup. The fittings and the blinding screws are mounted or dismounted by screwing (2Nm tightening torque) or unscrewing them with the provided 3 mm Allen key.

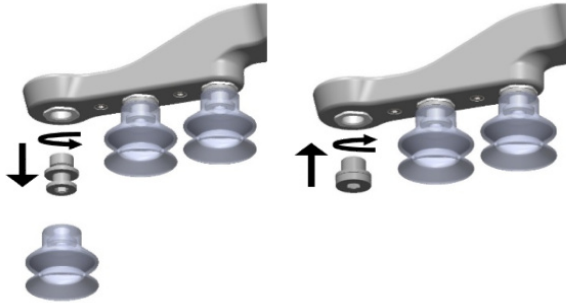

The thread size is the commonly used G1/8”; allowing for standard fittings, blinders and extenders to be fitted directly to the VG grippers.

Vacuum

Vacuum is defined as the percentage of absolute vacuum achieved relative to atmospheric pressure, i.e.:

% vacuum	Bar	kPa	inHg	Typically used for
0%	0.00rel.	0.00rel.	0.0rel.	No vacuum / No lifting capacity
	1.01 abs.	101.3 abs.	29.9 abs.	
20%	0.20rel.	20.3rel.	6.0rel.	Cardboard and thin plastics
	0.81 abs.	81.1 abs.	23.9 abs.	
40%	0.41rel.	40.5rel.	12.0rel.	Light workpieces and long suction cup life span
	0.61 abs.	60.8 abs.	18.0 abs.	
60%	0.61rel.	60.8rel.	18.0rel.	Heavy workpieces and strongly secured grips
	0.41 abs.	40.5 abs.	12.0 abs.	
80%	0.81rel.	81.1rel.	23.9rel.	Max. vacuum. Not recommended
	0.20 abs.	20.3 abs.	6.0 abs.	

The vacuum in kPa setting is the target vacuum. The pump will run at full speed until the target vacuum is achieved, and then run at a lower speed necessary to maintain the target vacuum.

The pressure in the atmosphere varies with weather, temperature and altitude. The VG grippers automatically compensate for altitudes up to 2km, where the pressure is about 80% of sea level.

Air Flow

Air flow is the amount of air that must be pumped to maintain the target vacuum. A completely tight system will not have any air flow, whereas real life applications have some smaller air leakages from two different sources:

- Leaking vacuum cup lips
- Leaking workpieces

The smallest leak under a vacuum cup can be hard to find (see picture below).

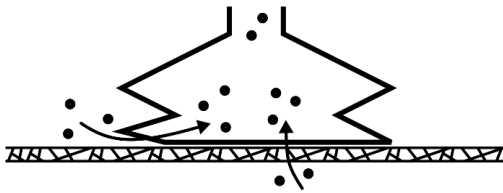

Leaking workpieces can be even harder to identify. Things that look completely tight might not be tight at all. A typical example is coarse cardboard boxes. The thin outer layer is often requiring a lot of air flow to create a pressure difference over it (see figure below).

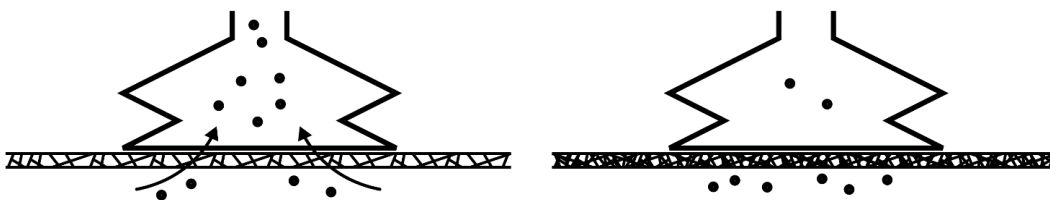

Therefore, the users must be aware of the following:

- VG grippers are not suitable for most uncoated, coarse cardboard boxes.
- Extra attention must be paid to leakages, e.g. vacuum cup shape and surface roughness

The air flow capability of a VG grippers is shown in the graph below:

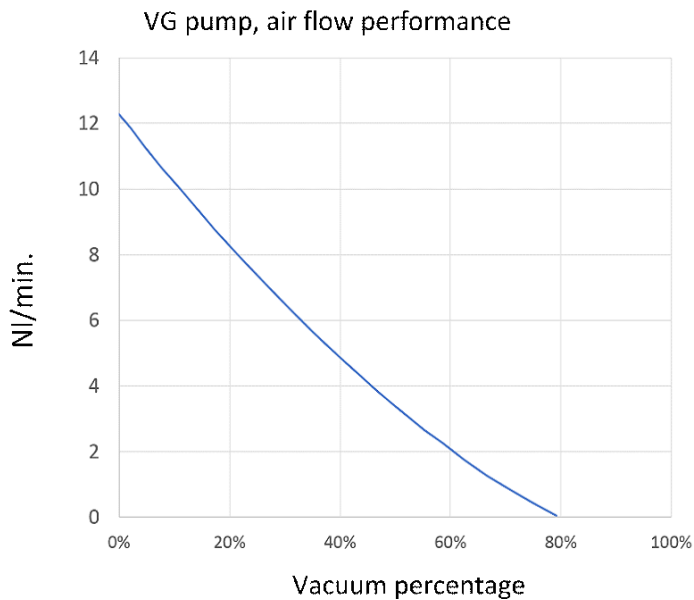



NOTE:

The easiest way to check if a cardboard box is sufficiently tight is simply to test it using the VG grippers.

A high vacuum percentage setting does not give a higher lifting capacity on corrugated cardboard. In fact, a lower setting is recommended, e.g. 20%.

A low vacuum setting results in less air flow and less friction below the vacuum cups. This means VG gripper filters and vacuum cups will last longer.

1.2. VGC10 box content

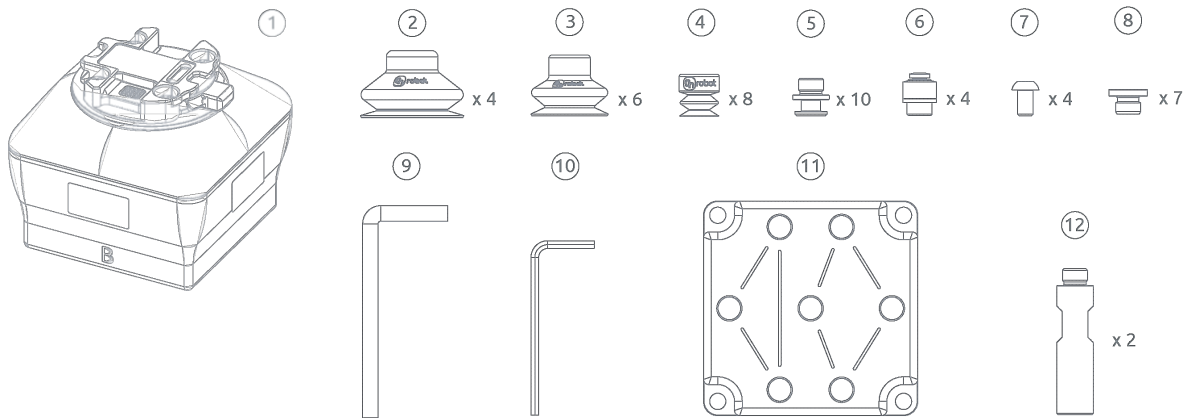

① VGC10

② d40 mm Vacuum Cups

③ d30 mm Vacuum Cups

④ d15 mm Vacuum Cups

⑤ Fittings

⑥ Push-in Fittings

⑦ M6x10 mm Screws

⑧ Blind screws

⑨ Torx T30

⑩ Allen 3 mm Keys

⑪ Adaptor Plate

⑫ Extension Pipe 50 mm

1.3. VGC10

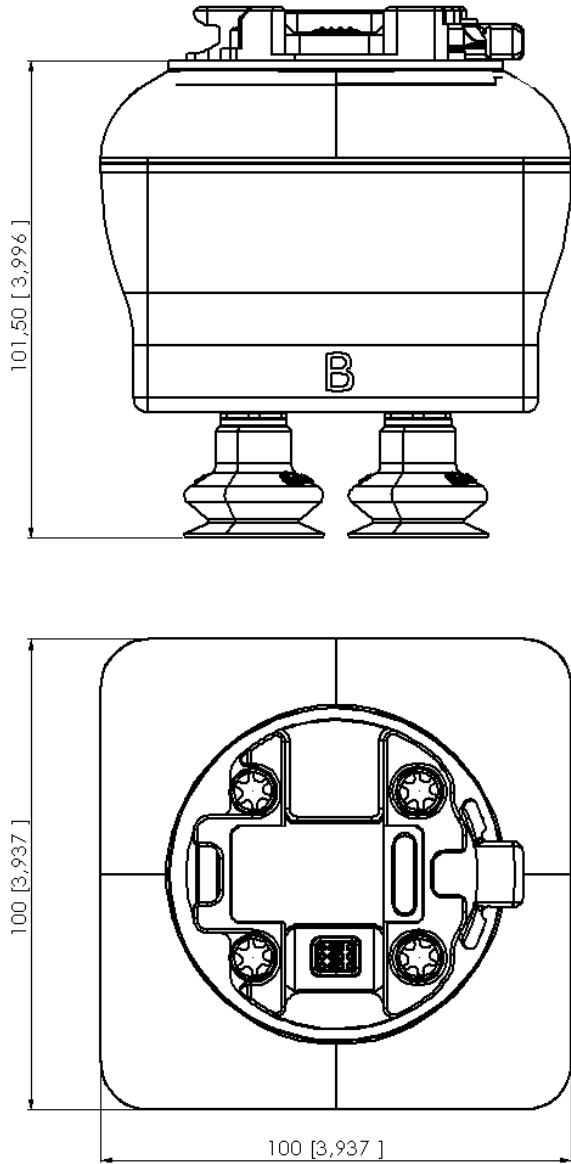

All dimensions are in mm and [inches].

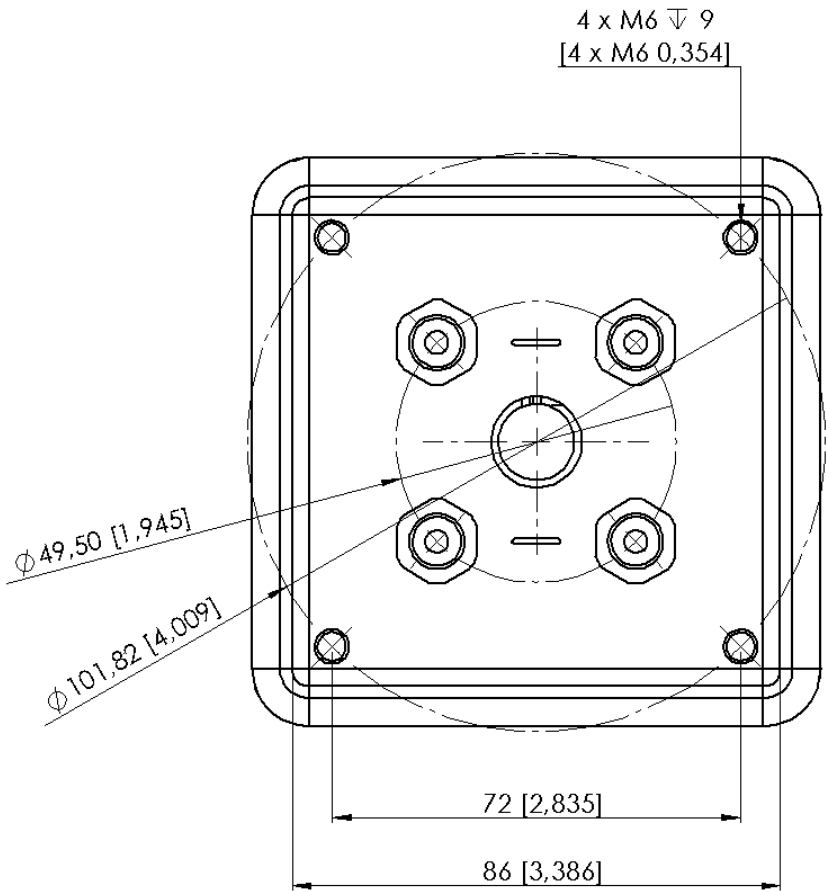

All dimensions are in mm and [inches].