



DATASHEET

VGP20

v1.5

1. Datasheet

1.1. VGP20

General Properties	Minimum	Typical	Maximum	Unit
Vacuum	5 % -0.05 1.5	- - -	60 % -0.607 17.95	[Vacuum] [Bar] [inHg]
Air flow in total	0	-	48	[L/min]
Air flow on each channel	0	-	12	[L/min]
Payload (with default attachments)	- -	10 ⁽¹⁾ 22.04	20 ⁽²⁾ 44.09	[kg] [lb]
Vacuum cups	1	16	24 ⁽⁵⁾	[pcs.]
Gripping time (measured with vacuum target 40%)	-	0.25 ⁽³⁾	-	[s]
Releasing time	-	0.4 ⁽³⁾	-	[s]
Noise level ⁽⁴⁾	-	67	71	[dB(A)]
Vacuum pump	Integrated, electric BLDC			
Dust filters	Integrated 50µm, field replaceable			
IP Classification	IP54 ⁽⁶⁾			
Dimensions	264 x 184 x 92 10.39 x 7.24 x 3.62			[mm] [inch]
Weight	2.55 5.62			[kg] [lb]

(1) The maximum payload capacity for standard cardboard is typically 10 kg, requiring the utilization of all available suction cups.

(2) 20 kg payload can be achieved with low accelerations (0.2G added to 1G; 1G = gravity = 9.82 m/s²). Other conditions may apply.

(3) The gripping time can be shortened with smaller or less suction cups. The release time depends on the payload. With high payload, you can achieve fast release time.

(4) For more information, see [Noise Level](#) section.

(5) Using the [High-payload Bracket](#) (Sold separately)

(6) Do not use vacuum grippers in wet or damp conditions, particularly in CNC applications with moisture or cutting fluids. It can damage the gripper.

Operating Conditions	Minimum	Typical	Maximum	Unit
Power supply	20.4	24	28.8	[V]
Current consumption	50	2500	4500	[mA]

Operating Conditions	Minimum	Typical	Maximum	Unit
Operating temperature (gripper and vacuum cups)	0	-	50	[°C]
	32	-	122	[°F]
Relative humidity (non-condensing)	0	-	95	[%]
Calculated operation life	25 000	-	-	[hours]

4 Channels

The VGP20 has 16 holes to use fittings with vacuum cups or blinding screws as needed. It also has lines which show the holes that are communicated together. This is useful when using the channels independently for vacuum.

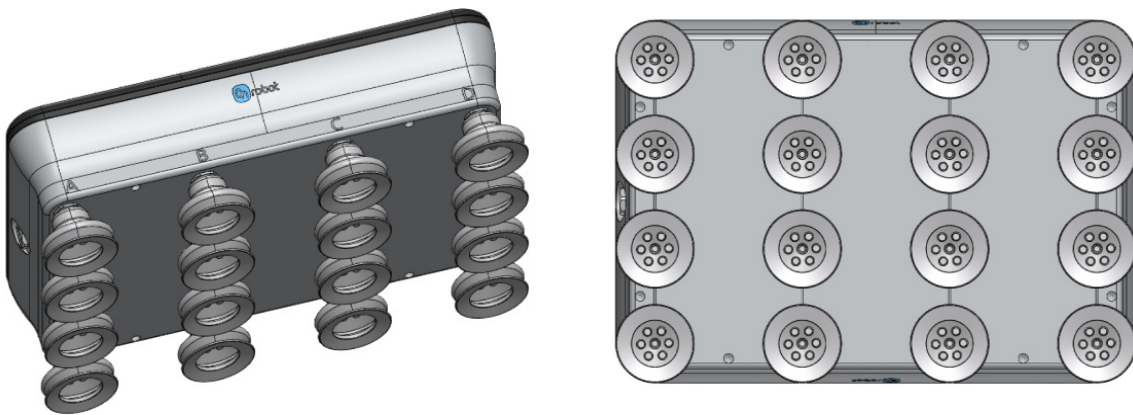

High-payload Bracket

The VGP20 can be used with a High-payload Bracket (Not included. Accessory Item #113922) that provides 24 holes for extra suction cups, offering more space between the workpiece centre. Furthermore, the bracket features 4 vacuum inlets, allowing for the connection of an external vacuum source when additional vacuum assistance is required. The bracket features three tie tube holes to securely position and organize the tubes when external vacuum is required. The bracket weight is 475 g (1.05 lb).

The High-payload Bracket includes the following components:

- (A)** Blinds x8
- (B)** Screws x8
- (C)** Suction Cups x8
- (D)** Vacuum Inlets x4
- (E)** Strips x3

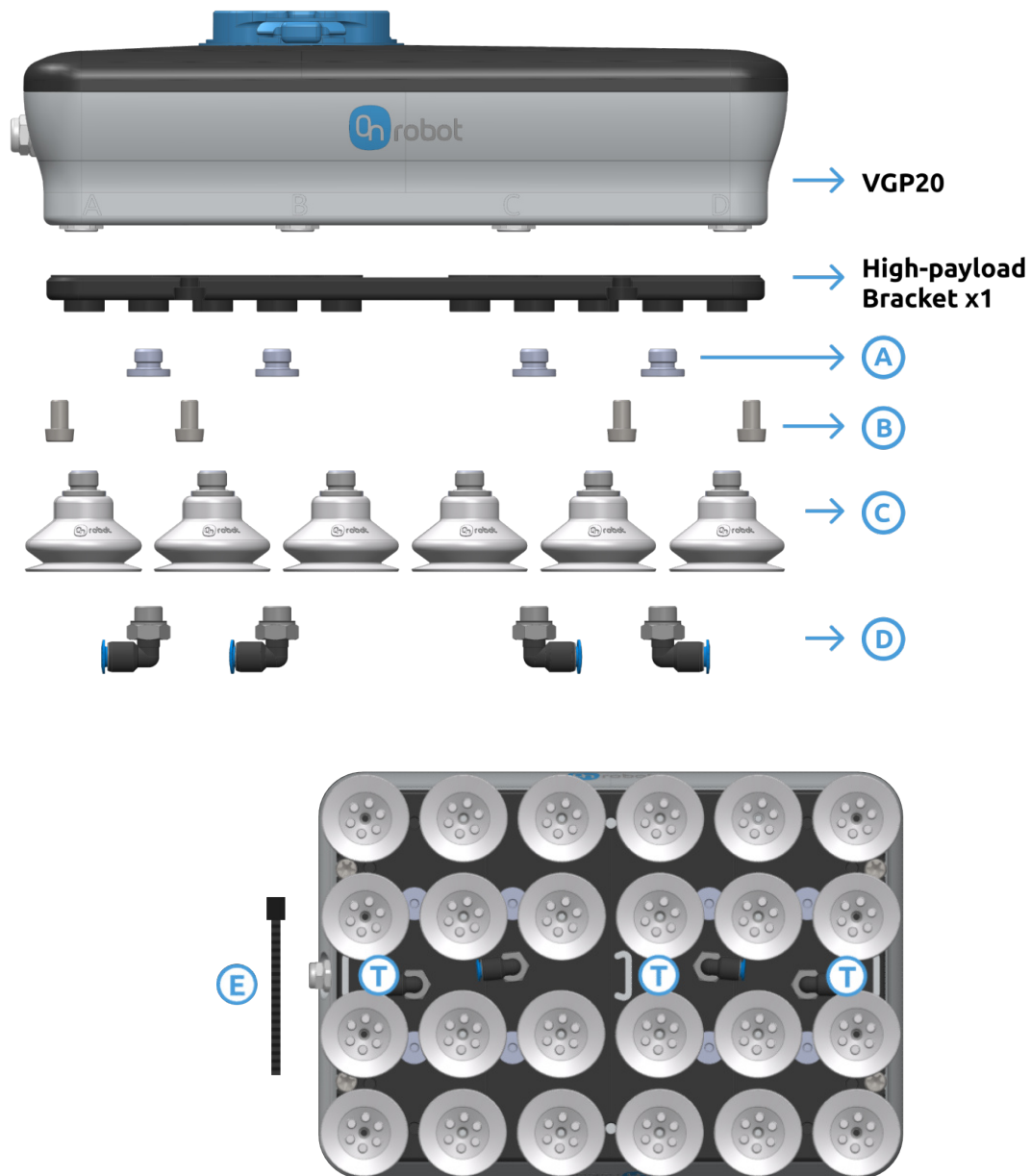

(T) The high-payload bracket features three tube tie holes designed to organize the vacuum tubes.

To mount the High-payload Bracket simply remove the fittings or blinding screws from the gripper, place the bracket and tighten the 8 screws.



NOTE:

When an external vacuum source is not being utilized, it is needed to position the blinds onto the brackets.

Determining Maximum Vacuum Based on the Workpiece

Different workpiece types have varying vacuum capabilities due to air leakage. Refer to the [Vacuum](#) and [Airflow](#) sections for more information.

A. Through D:PLOY/WebClient Setup

To find the maximum vacuum quickly, use a graphical user interface like D:PLOY/WebClient:

1. Attach all suitable suction cups.
2. Position the VGP20 on the workpiece in the desired gripping configuration.
3. Set target vacuum to 60 kPa.
4. Grip on all channels that engage your object.
5. Observe and record the current vacuum levels, which represent the maximum attainable target vacuum.
6. The lowest vacuum level obtained can be referenced in the accompanying graph as the recommended maximum payload. Examples are provided adjacent to the graph:

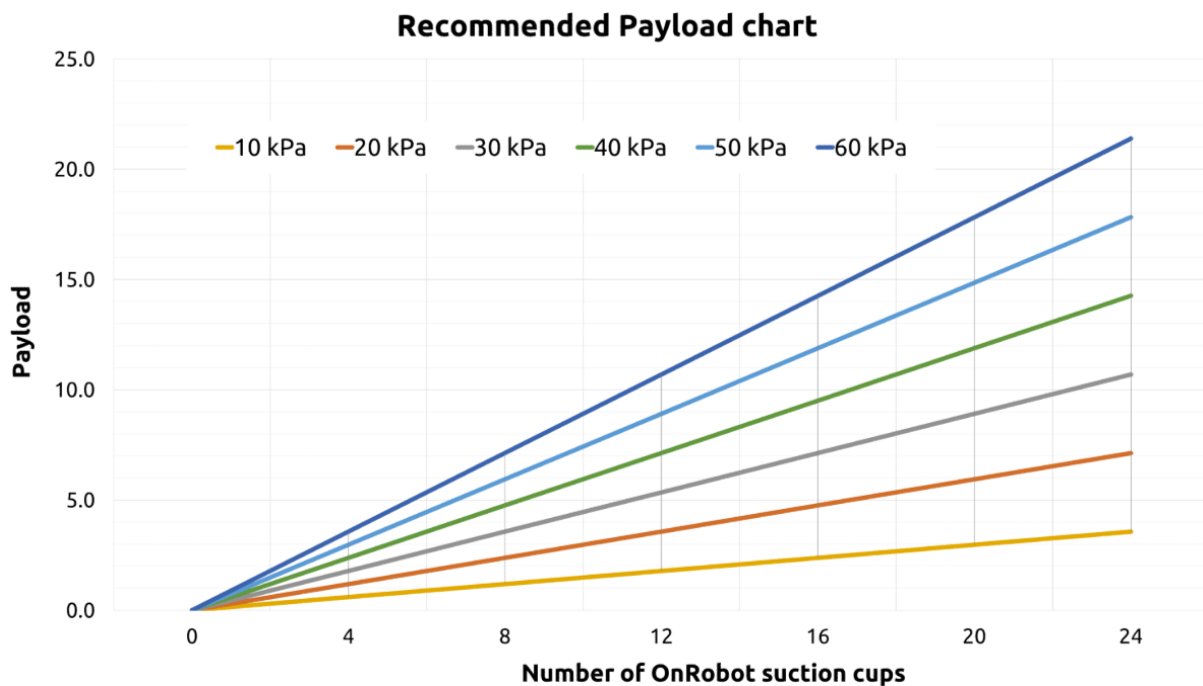

Example 1

- Payload: 4 kg
- Achievable vacuum level with 8 cups: 40 kPa

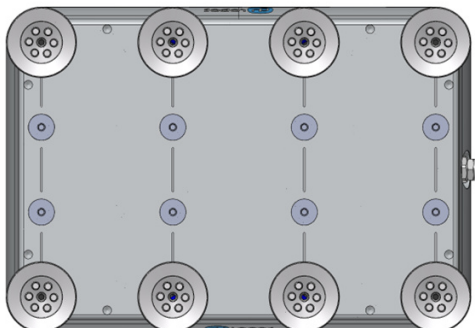

According to the graph, a minimum of 7 OnRobot standard suction cups is required. However, using 8 cups is more appropriate.

Example 2 (High-payload Bracket needed)

- Payload: 10 kg
- Achievable vacuum level with 20 cups: 35 kPa

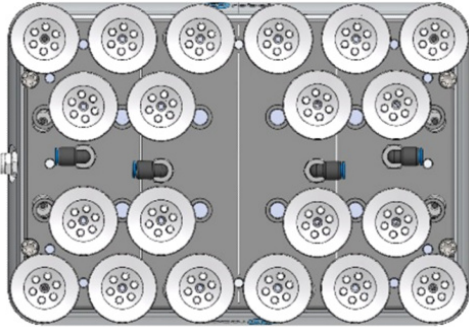

According to the graph, a minimum of 19 OnRobot standard suction cups is required. However, using 20 cups is more appropriate.

Example 3 (High-payload Bracket and an external vacuum needed)

- Payload: 15 kg
- Achievable vacuum level with 24 cups: 20 kPa

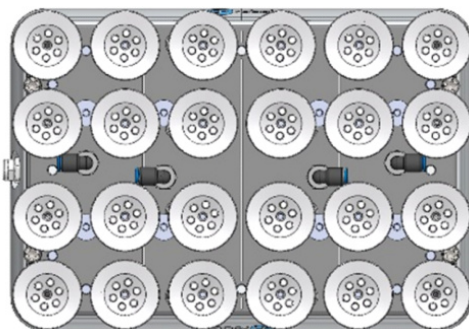

The number of OnRobot standard suction cups alone cannot meet the requirement. According to the graph, when using 24 cups, a minimum vacuum level of 42.5 kPa is necessary.

This indicates the need for assistance from an external vacuum source.

B. Through Manual Setup

In the absence of a graphical user interface or access to WebClient, follow these steps:

1. Set the target vacuum to 20% and verify if the gripper can attain it.
2. If successful, increase the target vacuum to 30% and check if the gripper can achieve it.
3. If successful, continue incrementing in 10% steps until the vacuum cannot be achieved.
4. When the vacuum cannot be achieved, decrease the target vacuum by 5% increments until the vacuum is successfully attained.

How to connect an external vacuum accessory



NOTE:

Max current ratings for digital outputs:

- OR:BASE 100 mA at 24 V DC.
- OR:MACHINE 1 A dry contacts max 60 VDC/VAC.
- Compute Box 100 mA total for 8 digital outputs at 24 VDC.

D:PLOY	Fully Supported
Manual robot program using a Compute Box	Create a WebLogic program
Palletizer App using a Compute Box	Not Supported

Through a Vacuum Pump

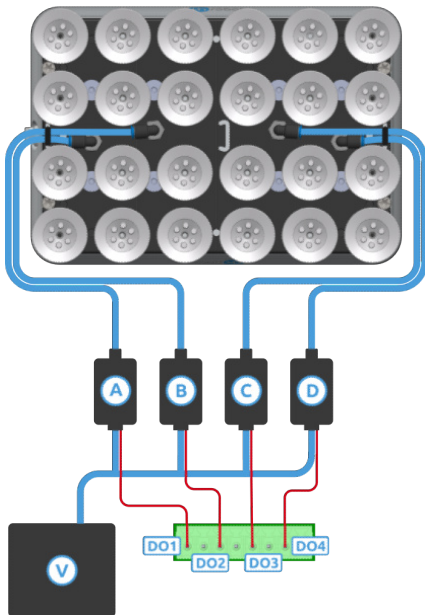

Establish a connection between the vacuum inlets of the bracket and the Vacuum Pump (V) using tubes.

Place valves (A, B, C and D) between them. We recommend using a Solenoid valve to allow a minimum capacity of suction flow rate of 100 L/min.

Through a Compressed Air Pump

Using compressed air is the preferred method to achieve an external vacuum. The examples below will explore different applications and features, with accompanying pneumatic diagrams for clarity.

To establish a connection between the vacuum inlets of the bracket and the Compressed Air Pump (P), use tubes.

Place valves between them. We recommend using a Solenoid valve to allow a minimum capacity of suction flow rate of 100 L/min. To achieve a vacuum, incorporate vacuum ejectors. We recommend using a SMC ZU07SA model.

Ensure that each valve is connected to a Digital Output (DO1, DO2, DO3 and/or DO4) for controlling the vacuum.

4 channel external vacuum for boxes and no interlayer

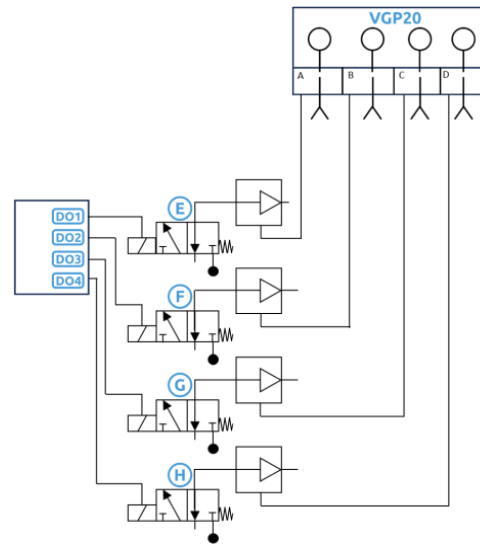
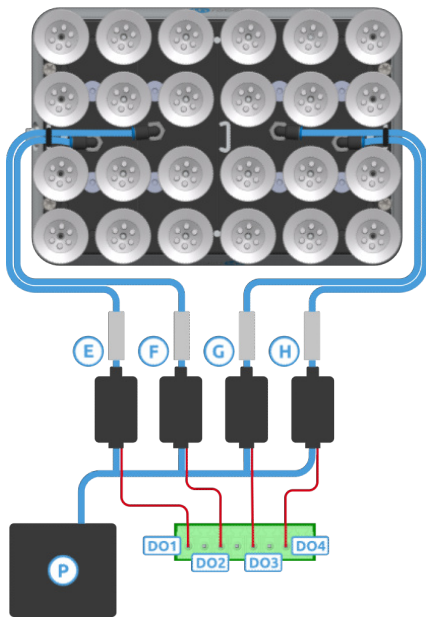

Place valves (E, F, G and H) between the inlets and the Compressed Air Pump (P).

Setup the DO1, DO2, DO3, and DO4 to follow the VGP20 channel A, B, C, and D.

The A, B, C, and D channel are used on VGP20.

The DO1 – DO4 will activate the external vacuum.

One channel external vacuum for boxes and no interlayer

Example with only one external vacuum generator. When only one valve and one injector are used the size must be larger to generate sufficient vacuum flow for 4 channels.

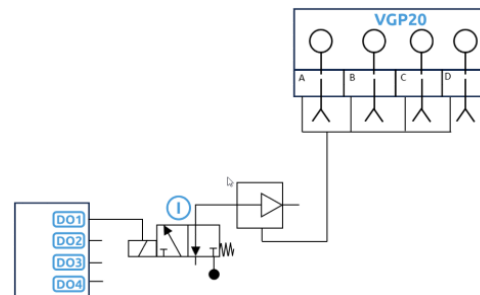
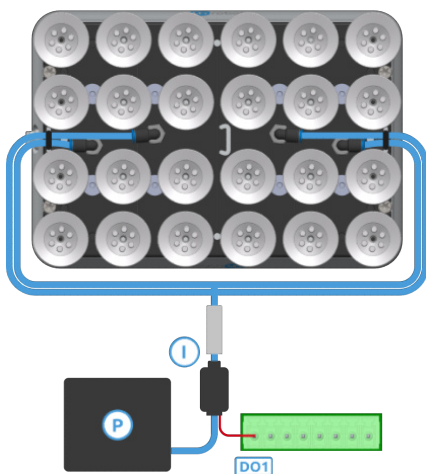

Place a valve (I) between the inlets and the Compressed Air Pump (P).

Setup the DO1 to follow the VGP20 channel A.

The A, B, C, and D channel are used on VGP20.

The DO1 will activate the external vacuum.

One channel external vacuum for boxes and interlayer

Example with only one external vacuum generator. When only one valve and one injector are used the size must be larger to generate sufficient vacuum flow for 4 channels.

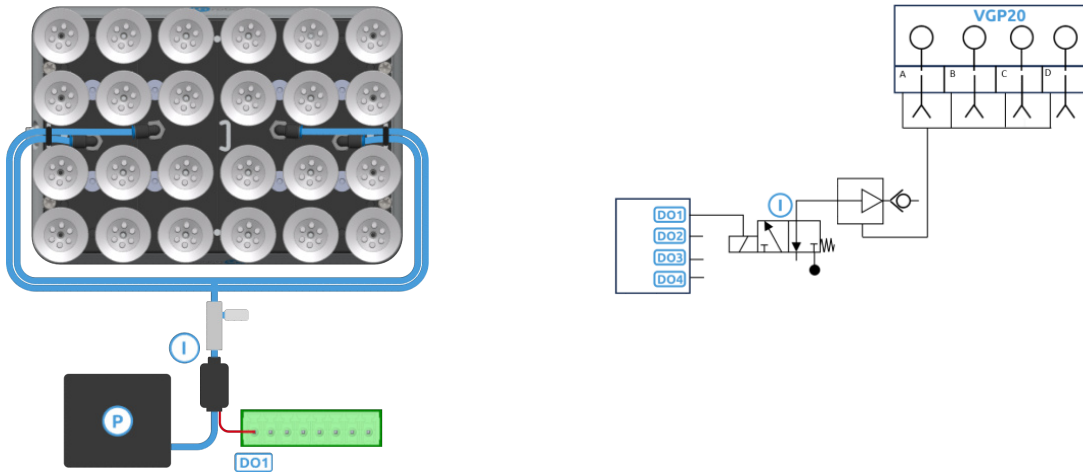

Place a valve (I) between the inlets and the Compressed Air Pump (P).

Setup the DO1 to follow the VGP20 channel A. When handling boxes A, B, C, and D channels are used on VGP20. The DO1 will activate the external vacuum.

When handling Interlayers the B, C, and D channels are used. The DO1 is not activated. The one-way valve stops the air leak through the vacuum injector and a low target vacuum can be selected in the pick sequence for interlayers.

Two channels external vacuum for boxes with blow off functionality and interlayer

When only two valves and two injectors are used the size must be larger to generate sufficient vacuum flow for 4 channels.

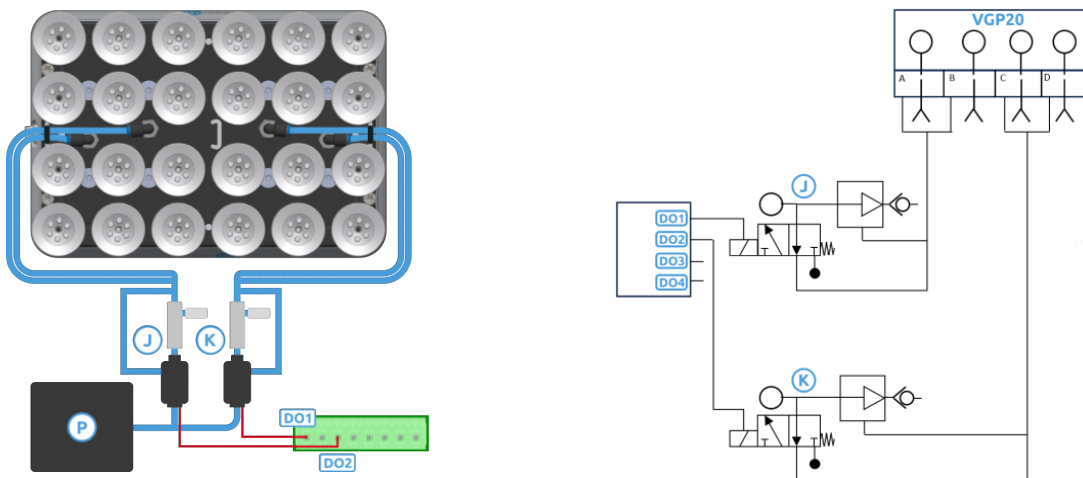

Place valves (J and K) between the inlets and the Compressed Air Pump (P).

Setup the DO1 and DO2 to follow the VGP20 channel A and D.

When handling boxes A, B, C, and D channel are used on VGP20. The DO1 and DO2 will activate the external vacuum.

When handling Interlayers the B and C channel are used. The DO1 and DO2 are not activated. The one-way valves stop the air leak through the vacuum injectors and a low target vacuum can be selected in the pick sequence for interlayers. The power of the blow off functionality depends on the size of the reservoir, the length, dimension of the tubes etc.

Iconography	Description	Iconography	Description
	One mono stable three port valve.		ON State
	Off State		Reservoir
	Vacuum Injector A - Compressed Air V - Vacuum E - Exhaust		Compressed air supply

Vacuum Cups

The gripper comes with common 40 mm silicone vacuum cups (see table below) which are good for hard and flat surfaces, but not good for uneven surfaces and it might leave microscopic traces of silicone on the workpiece which can cause issues with some types of painting processes afterwards.

Image	External Diameter [mm]	Internal Diameter [mm]	Gripping Area [mm ²]
	40	24	450

For non-porous materials, the OnRobot suction cups are highly recommended. Some of the most common non-porous materials are listed below:

- Composites
- Glass

- High density cardboard
- High density paper
- Metals
- Plastic
- Porous materials with a sealed surface
- Varnished wood

It is often a good idea to use more vacuum cups than needed, to accommodate for vibrations, leaks and other unexpected conditions. However, the more vacuum cups, the more air leakage (air flow) is expected and the more air is moved in a grip resulting in longer gripping times.

When using porous materials, the vacuum that can be achieved by using the OnRobot suction cups will depend on the material itself and will be between the range stated in the specifications. Some of the most common porous materials are listed below:

- Fabrics
- Foam
- Foam with open cells
- Low density cardboard
- Low density paper
- Perforated materials
- Untreated wood

The following graph provides an overview of the vacuums that can be achieved depending on the workpiece porosity.

Porousness vs Vacuum graph

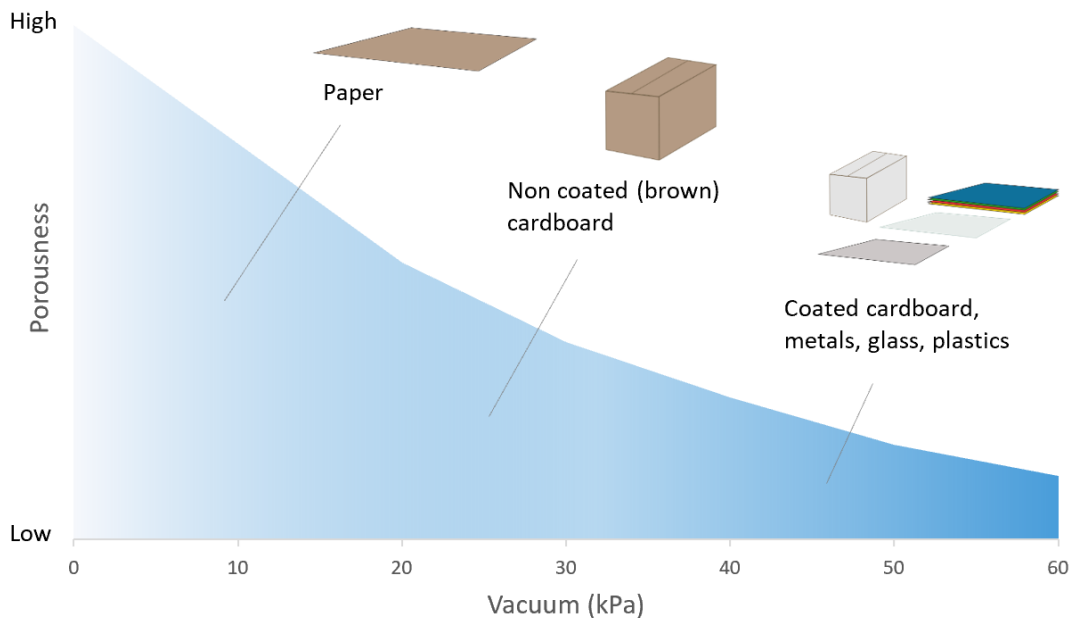

See the table below with general recommendations, in case other suction cups are needed for specific materials.

Workpiece surface	Vacuum cup shape	Vacuum cup material
Hard and flat	Normal or dual lip	Silicone or NBR
Soft plastic or plastic bag	Special plastic bag type	Special plastic bag type
Hard but curved or uneven	Thin dual lip	Silicone or soft NBR
To be painted afterwards	Any type	NBR only
Varying heights	1.5 or more bevels	Any type



NOTE:

It is recommended to consult a vacuum cup specialist to find the optimal vacuum cup where the standard types are insufficient.

Suction Cups for Foil and Bags Ø25

This suction cup improves the vacuum gripper’s ability to pick and place workpieces with surface of foil, thin paper, and plastic bags during irregular and angular arm movement.

	 25 mm							
Number of Cups	1	2	3	4	5	6	7	8
Surface	kg							
Foil	0.83	1.07	1.43	1.57	1.79	2.03	2.27	2.51
Thin paper	1.08	1.71	2.23	3.21	3.74	4.37	5	5.63
Foil - round shape	1.28	2.32	3.32	4.25	5.44	6.48	7.52	8.56
Plastic bag	0.32	0.54	0.63	0.74	0.94	1.09	1.25	1.405

The vacuum cup is silicone rubber compliant with the USA Food and Drug Administration (FDA).

Using this vacuum cup reduces the wrinkles made on thin workpieces (film, vinyl, and so on)

during absorption:  .

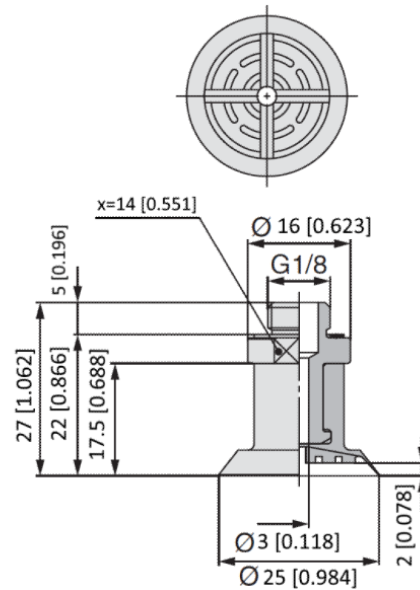

This vacuum cup is an accessory and need to be purchased separately. To purchase the vacuum cup, contact the vendor from where the VGx gripper has been purchased.

- Suction Cups for foil and bags Ø25 - PN 106964

Vacuum

Vacuum is defined as the percentage of absolute vacuum achieved relative to atmospheric pressure, i.e.:

% vacuum	Bar	kPa	inHg	Typically used for
0%	0.00rel. 1.01 abs.	0.00rel. 101.3 abs.	0.0rel. 29.9 abs.	No vacuum / No lifting capacity
20%	0.20rel. 0.81 abs.	20.3rel. 81.1 abs.	6.0rel. 23.9 abs.	Cardboard and thin plastics
40%	0.41rel. 0.61 abs.	40.5rel. 60.8 abs.	12.0rel. 18.0 abs.	Light workpieces and long suction cup life span
60%	0.61rel. 0.41 abs.	60.8rel. 40.5 abs.	18.0rel. 12.0 abs.	Heavy workpieces and strongly secured grips

The vacuum in kPa setting is the target vacuum. The pump will run at full speed until the target vacuum is achieved, and then run at a lower speed necessary to maintain the target vacuum.

The pressure in the atmosphere varies with weather, temperature and altitude. The gripper automatically compensates for altitudes up to 2 km, where the pressure is about 80% of sea level.

Airflow

Airflow is the amount of air that must be pumped to maintain the target vacuum. A completely tight system will not have any airflow, whereas real life applications have some smaller air leakages from two different sources:

- Leaking vacuum cup lips
- Leaking workpieces

The smallest leak under a vacuum cup can be hard to find (see picture below).

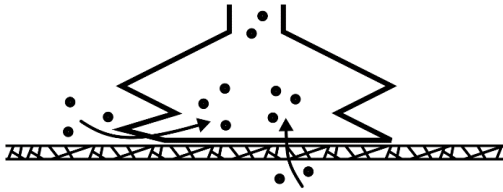

Leaking workpieces can be even harder to identify. Things that look completely tight might not be tight at all. A typical example is coarse cardboard boxes. The thin outer layer is often requiring a lot of airflow to create a pressure difference over it (see figure below).

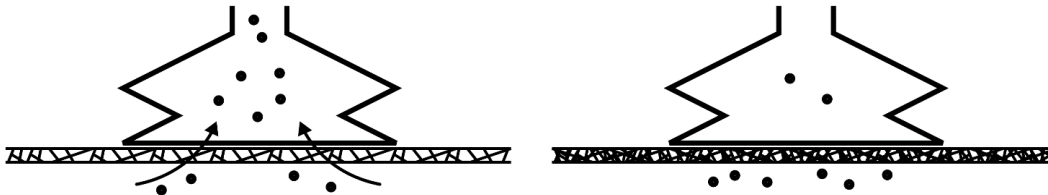

Be aware of the following:

- Pay extra attention to leakages, e.g. vacuum cup shape and surface roughness.
- When gripping an object with high leakage, be sure to use as many of the channels A, B, C, and D as possible.

The following graph shows the airflow capability of the gripper.



NOTE:

The airflow depends on the number of used channels.

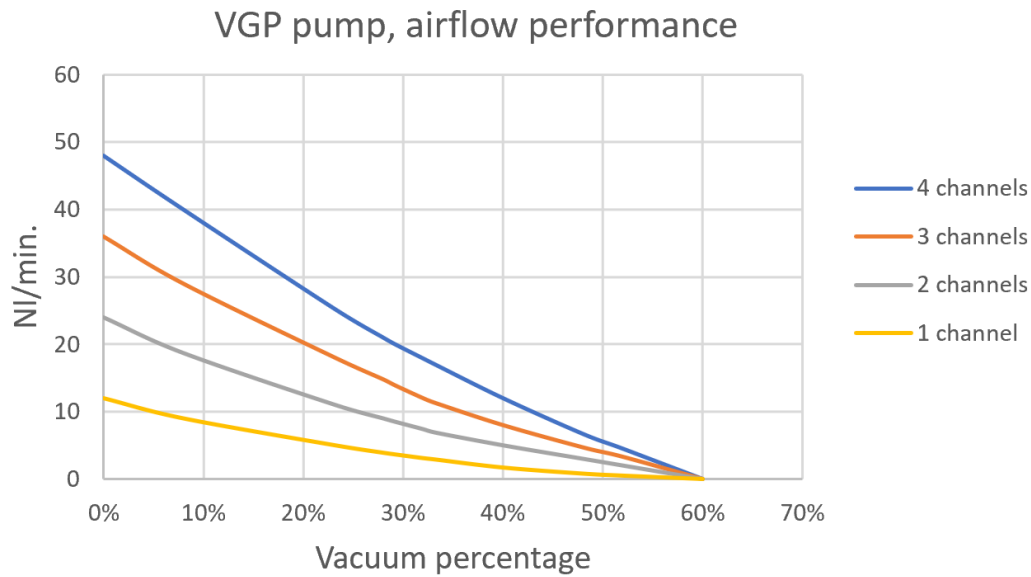
**NOTE:**

The easiest way to check if a cardboard box is sufficiently tight is simply to test it using the gripper.

A high vacuum percentage setting does not give a higher lifting capacity on corrugated cardboard. In fact, a lower setting is recommended, e.g. 20%.

A low vacuum setting results in less air flow and less friction below the vacuum cups. This means that the filters and the vacuum cups will last longer.

Fittings and Blind Screws

It is possible to change the suction cups simply by pulling them off the fittings. Stretch the silicon to one of the sides and then pull the suction cup out.

Unused holes can be blinded using a blind screw, and each fitting can be changed to a different type to match the desired suction cup. The fittings and the blinding screws are mounted or dismounted by screwing (2 Nm tightening torque) or unscrewing them with the provided 3 mm hex key.

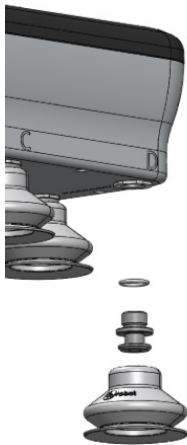
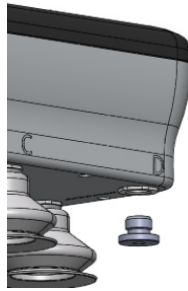
**Fittings****Blind**

The thread size is the commonly used G1/8"; allowing for standard fittings, blinders, and extenders to be fitted directly to the gripper.

Remove Pump Exhaust

It is possible to lead the pump exhaust air away from the gripper. By removing the silencer on the side of the gripper, a G1/8 thread is available for a fitting and a tube to guide away the exhaust.

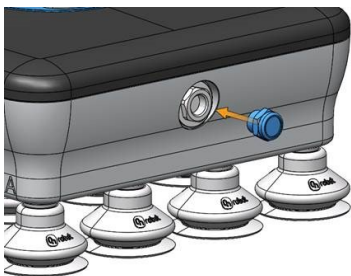

Customize the Gripper

You can mount any customized equipment needed by using the available M6 threads on the bottom surface of the gripper.

Examples of a customized gripper:

- A plate is mounted to the gripper by the M6 holes in the cabinet. The plate thickness has to be at least 12 mm to fit the suction cup and the fitting.
- The plate has 8 G1/8 threads through the plate for the suction cups. The existing suction cups including fittings can then be used.

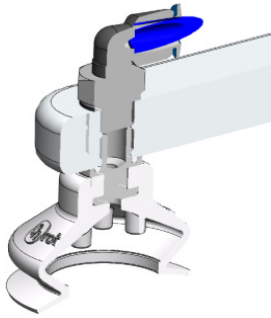

- G1/8 fittings can be used directly above the suction cups (this is not included).
- Same fitting can be used on the gripper and tubes can then be mounted in between.
- To get optimum lifting capacity, the suction cups must be divided equally for each channel on the gripper.

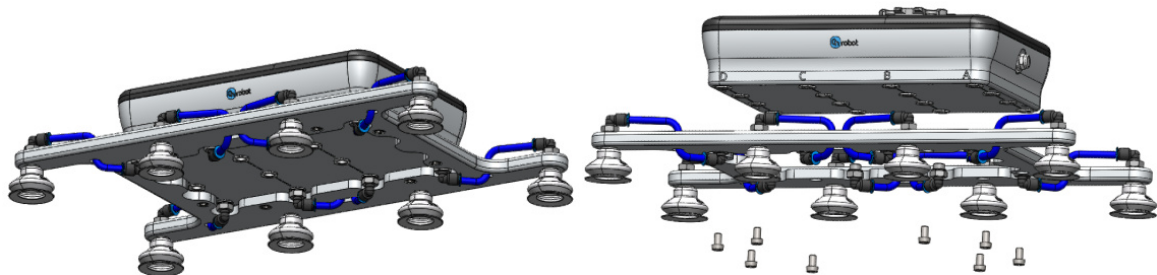
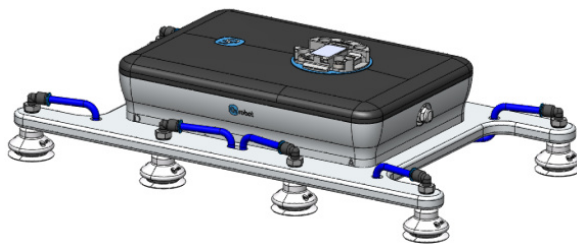
**NOTE:**

For frames that are larger than twice the size of the VGP20, we recommend installing a stabilizing structure. This will help minimize deflection in the gripper and protect the QC from continuous stress during acceleration and deceleration. See examples below of how such stabilizers can be designed.

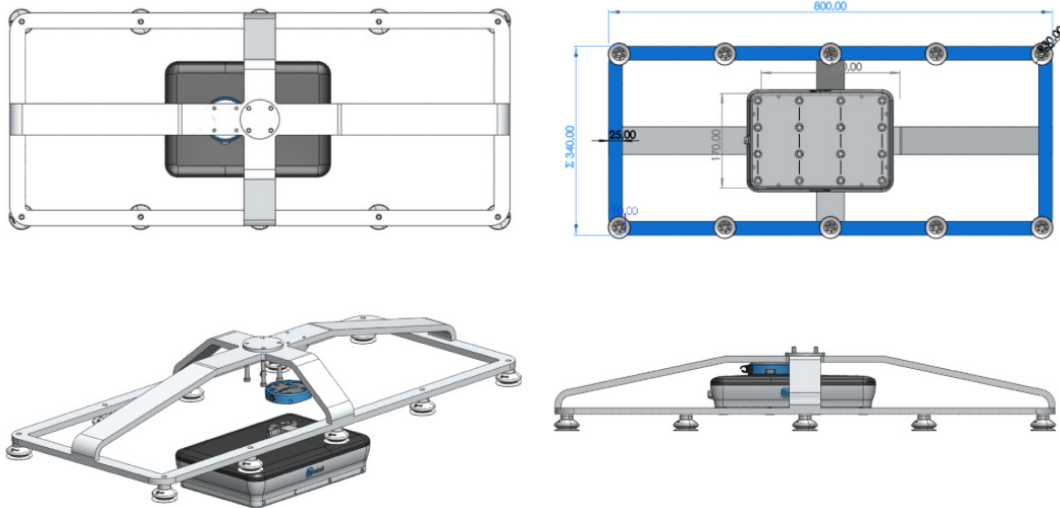

Noise Level

The noise level of the gripper depends on the workpiece's surface and geometry, and more specifically on the leakage of the surface. It also depends on the surroundings and other equipment.

To measure the VGP20's noise level, a test has been carried out by an external company.

The test setup was the following:

- The test took place on a normal indoor production area.
- They used 4 different uncoated and 1 coated coarse cardboard as workpiece.
- The test run 4 cycles combining grips, robot moving holding the workpiece for 8 seconds, robot moving without the workpiece for 7 seconds, and releases.
- The noise measurement equipment was located 1 m distance from the robot arm.

The test concludes that the average measured noise level for the worst box was 71 dB(A) and the average noise for the 5 boxes was 67 dB(A) which is far below the maximum allowed noise level (80 dB(A)). Therefore, similar setups will not cause hearing damage on people remaining close to the VGP20.

Using a more dense uncoated cardboard as workpiece will significantly drop the noise level.

1.2. VGP20 box content

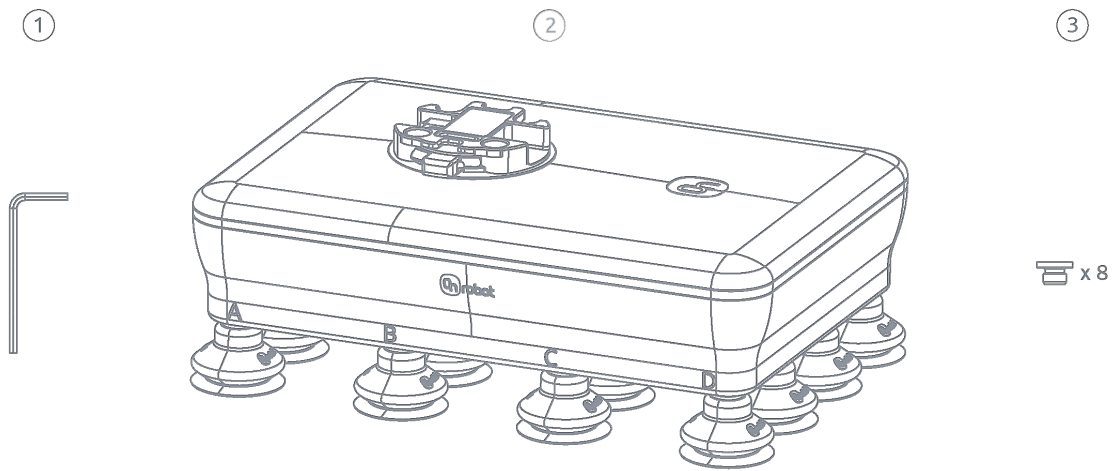

① Hex Key 3 mm

② VGP20

③ Blind screws

1.3. VGP20

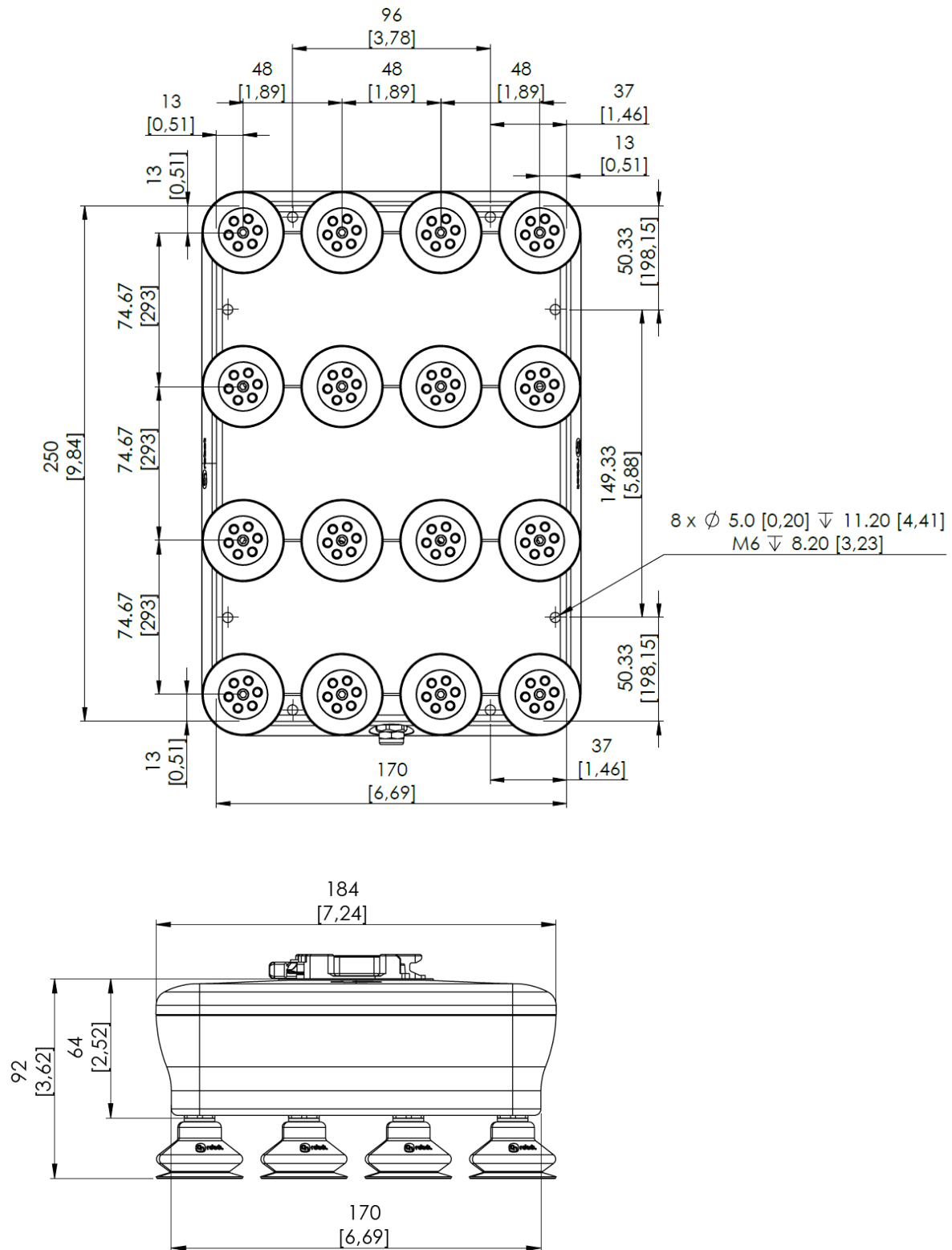

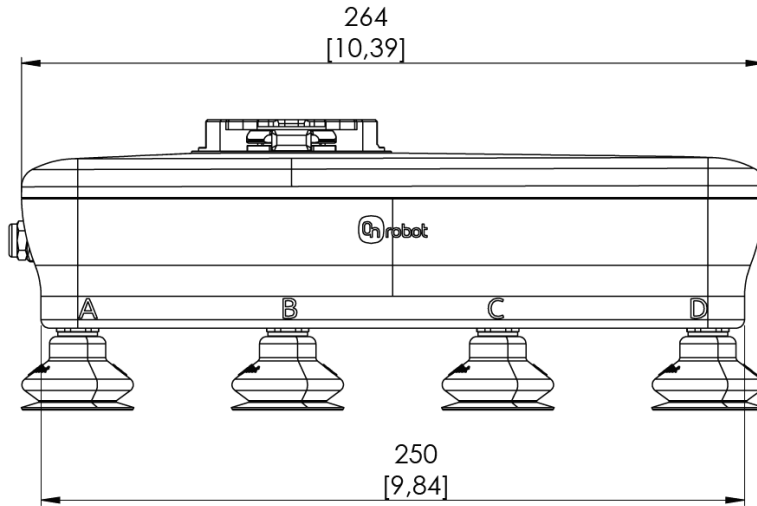

VGP20 High-payload Bracket

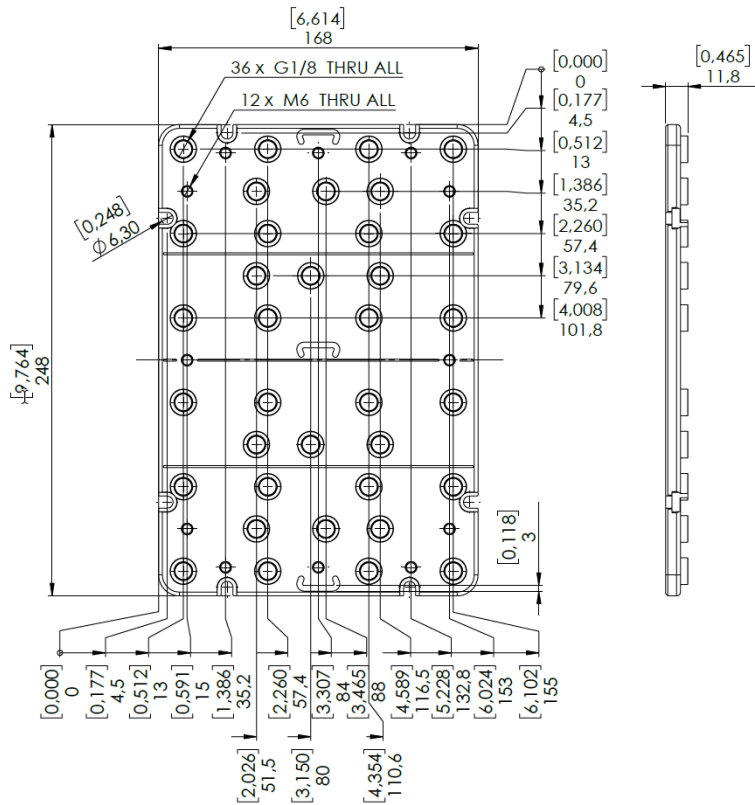

All dimensions are in mm and [inches].