

One Stop Shop for Collaborative Applications

Grow your business with new technology



One System, Zero Complexity, Unlimited Opportunities

Save integration time and simplify
deployment with our complete solution.

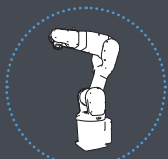

ABB

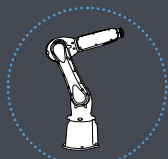

Kawasaki

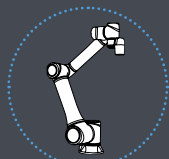

Techman

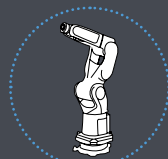

Fanuc



Kassow

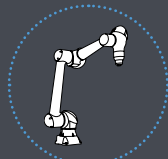

Yaskawa



Nachi



Doosan

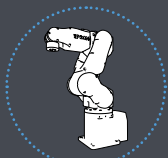

Epson

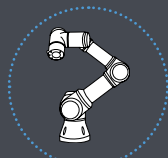

Universal
Robots

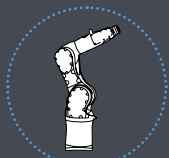

Kuka



Hanwha

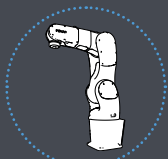

Denso



JAKA



Omron



Elite

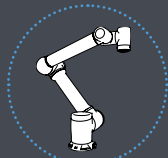

Schneider

QUICK CHANGER



Fits all robots



DUAL QUICK CHANGER



Your robot*

*If your robot arm is not represented above, contact your local partner for information on compatibility on other robot brands.



2FG7



2FG14



3FG15



3FG25



Soft Gripper



Gecko Gripper



VG10



OnRobot Sander



OnRobot Screwdriver



HEX



OnRobot Eyes



VGC10

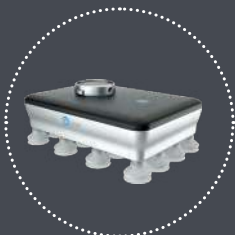

VGP20



2FGP20



Lift100



RG2/RG6



D:PLOY Palletizing



D:PLOY Packaging



D:PLOY Transferring



D:PLOY CNC



D:PLOY

The next big leap in automation

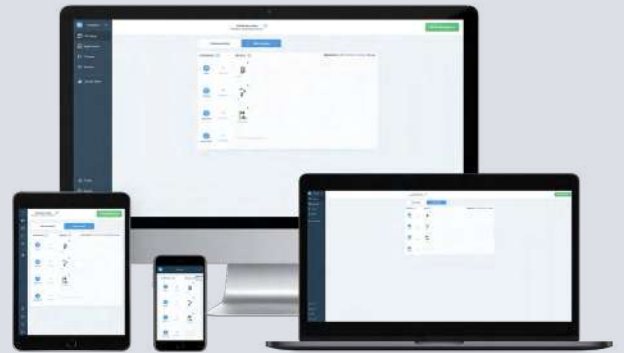

The field of automation has grown tremendously over the last decades. Although many manufacturers have embraced automation, high barriers to implementation remain, especially among small and medium-sized companies. Deploying robotic applications on the manufacturing floor is still far too complex, time-consuming, and inflexible. With D:PLOY, this is a thing of the past. By reducing the complexity of robotic application deployment, manufacturers can finally reap the benefits of automation. The deployment will be faster, easier, and more affordable.

ONLINE

ONSITE

**UP TO 90%
TIME SAVINGS**

The D:PLOY platform combines hardware and software to deliver solutions that address various robotic applications. Today, D:PLOY supports the following applications, with more to follow.



D:PLOY
Palletizing



D:PLOY
Packaging



D:PLOY
CNC



D:PLOY
Transferring

Finally reap the benefits of robotic automation and stay ahead of competition

- ~ D:PLOY breaks down automation barriers so you can automate faster, easier, and without risk
- ~ With dramatic time savings of up to 90% on deployment and re-deployment, automation comes at a lower cost and more attractive ROI
- ~ Reap the benefits of automation and solve your labor shortage problems, improve productivity, relieve operators from unwanted tasks, and stay ahead of the competition
- ~ Take control of your automation journey by making changes to the application yourself when production requirements change, and ensure minimum downtime



Automate faster, easier, and without risk

D:PLOY offers an unprecedented reduction in robotic cell deployment time and complexity, resulting in dramatic time savings of up to 90% over conventional approaches.

D:PLOY helps bring down overall automation costs by reducing deployment and re-deployment time. Manufacturers will see faster, lower-cost implementation for better ROI, while gaining control over ongoing automation changes.



Take control of your automation journey

When production requirements change, D:PLOY gives you the flexibility to quickly re-deploy the application, for example when introducing a new part.

- ✓ Save time and money on re-deployments
- ✓ Make changes to the application yourself when you need it
- ✓ Access monitoring data on and off-site for improving productivity and reducing downtime



How D:PLOY works

The powerful D:PLOY platform allows you to build complete applications directly on the manufacturing floor in a few simple steps, with zero programming and zero simulations.

To get started, install the OR:BASE and cell components and configure your robot. Simply scan the QR codes provided to connect your device (e.g., tablet) to the OR:BASE, and then to login to D:PLOY.



1 Cell setup

Automatically discovers most of the installed hardware and configures interfaces, providing immediate control over them.



2 Workspace

Workspace

Automatically generates a collision-free path depending on the obstacles defined.

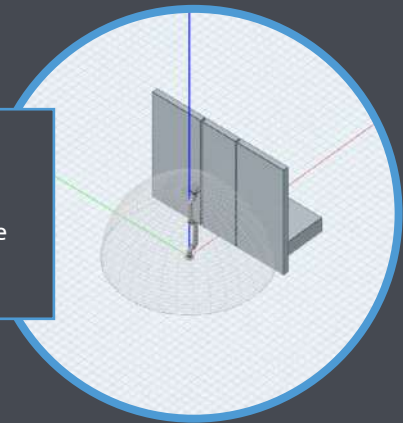

3 Application setup

Automatically generates all the program logic, signals exchange, events handling, and path planning of the robot for the entire application based on a few inputs.

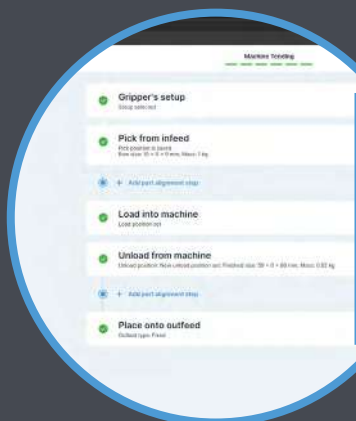

4 Operate and monitor

Operate and monitor

Operate with ease and gain insights into performance indicators – all in real-time and with limited configuration needed.



5 Re-deploy

Re-deploy

D:PLOY delivers the flexibility and re-deployment speed to respond quickly to changes in production requirements.

OnRobot Eyes

Adding vision to robotic applications has never been easier



POWER UP PRODUCTION

- Adding vision to robotic applications has never been easier, with one-picture calibration, fast programming and seamless gripper integration
- Flexible, adaptable vision system with on-robot or external mounting is ideal for almost any collaborative application
- Inspect objects using color and contour detection — with or without a robot, and ensure consistent quality
- Affordable, efficient 2.5D vision offers depth perception for varying heights or stacked objects
- Easily sort, pick and place unstructured applications with high reliability using any robot arm
- One-shot detection for multiple objects minimizes cycle time
- Automatic landmark enables dynamic working environments and mobile robot setups



TECHNICAL SPECIFICATIONS

Camera Characteristics				Unit	
Interface	USB-C 3.x				
Output Resolution	1280 x 720			[px]	
Working distance	400-1000 [15.75 – 39.37]			mm [inch]	
Operating Temperature	0 – 35 [32 – 95]			°C [°F]	
IP rating	IP 54				
Weight	0.260 [0.57]			kg [lb]	
Eyes Features				Unit	
Type of vision system	2.5 D				
Minimum part size	10x10 or 15 diameter [0.39x0.39 or 0.59 diameter]			mm [inch]	
Applications Supported	Detection, Sorting, Inspection, Landmark				
Mounting options supported	Robot and External				
Reconfigurability when Robot mounted	12 configurations (4 x 3)				
	Around robot's flange		Tilt orientations		
	0 - 90 - 180 - 270	0 - 45 - 90		[degrees]	
Detection Repeatability	< 2 [< 0.078]			mm [inch]	
Detection Accuracy (typical) measured at 500 mm	External Mount		Robot Mount		
	2 [0.078]		2 [0.078]		mm [inch]
Minimum Inspection Defect Size	5 [0.197]			mm [inch]	
Landmark accuracy **	Waypoint distance from Landmark	Minimum error	Typical error	Maximum error	
	200 [7.874]	0.2635 [0.0104]	0.6596 [0.0260]	0.9500 [0.0374]	mm [inch]
	500 [19.68]	0.6586 [0.0259]	1.6490 [0.0649]	2.3750 [0.0935]	mm [inch]
	1000 [39.37]	1.3173 [0.0519]	3.2981 [0.1298]	4.7500 [0.1870]	mm [inch]

Versatile electric gripper for palletizing heavy cardboard boxes, open boxes and other containers that cannot be gripped with vacuum



POWER UP PRODUCTION

- Highly versatile palletizing gripper with wide stroke and customizable arms to handle heavy or open boxes, shelf-ready products and other containers that can't be gripped with vacuum
- Integrated vacuum gripper handles slip sheets without changing the gripper or requiring other handling method
- Off-the-shelf gripper saves significant engineering effort and shortens deployment time
- Electric gripper offers fast out-of-the-box deployment without the complexity and costs of external air supply



TECHNICAL SPECIFICATIONS

Finger Grip Properties	Minimum	Typical	Maximum	Unit
Payload	-	-	20	[kg]
	-	-	44.1	[lb]
Total stroke	-	260	-	[mm]
	-	10.24	-	[inch]
Grip width range	170	-	430	[mm]
	6.69	-	16.93	[inch]
Gripping repeatability	-	+/- 0.5	-	[mm]
	-	+/- 0.0197	-	[inch]
Gripping force	80	-	400	[N]
Gripping speed	16	-	180	[mm/s]
Gripping time (incl. brake activation)	-	600	-	[ms]
Hold workpiece if power loss?	Yes			
Motor	Integrated, electric BLDC			
IP Classification	54			
Dimensions	400 x 121.6 x 188			[mm]
	15.75 x 4.79 x 7.4			[inch]
Weight	3.5			[kg]
	7.72			[lb]

Vacuum Grip Properties	Minimum	Typical	Maximum	Unit
Vacuum	5	-	60	[%Vacuum]
	- 0.05	-	- 0.607	[Bar]
	1.5	-	17.95	[inHg]
Air flow	0	-	12	[L/min]
Payload (with delivered attachments)	-	-	2.5	[kg]
	-	-	5.51	[lb]
Vacuum cups	1	-	4	[pcs]
Gripping time (measured with vacuum target 40%)	-	0.25	-	[s]
Release time	-	0.4	-	[s]
Vacuum pump	Integrated, electric BLDC			
Dust filters	Integrated 50 µm, field replaceable			

VGP20

Industry's most powerful electric vacuum gripper



POWER UP PRODUCTION

- Industry's most powerful electric vacuum gripper saves up to 90% over pneumatic grippers
- Ideal for palletizing cardboard boxes and other irregular shapes and porous surfaces
- Highly versatile gripper with unlimited customization fits any application
- Built-in intelligence and multichannel functionality ensure failsafe, flexible operation
- Complete out-of-the-box vacuum gripper offers fast, easy deployment with any leading robot

TECHNICAL SPECIFICATIONS

General Properties	Minimum	Typical	Maximum	Unit
Vacuum	5%	-	60%	[Vacuum]
	-0.05	-	-0.607	[Bar]
	1.5	-	17.95	[inHg]
Air flow in total	0	-	48	[L/min]
Air flow on each channel	0	-	12	[L/min]
Payload (with default attachments)	-	10 ⁽¹⁾	20 ⁽²⁾	[kg]
	-	22.04	44.09	[lb]
Vacuum cups	1	16	16	[pcs.]
Gripping time (measured with vacuum target 40%)	-	0.25 ⁽³⁾	-	[s]
Releasing time	-	0.4 ⁽³⁾	-	[s]
Noise level ⁽⁴⁾	-	67	71	[dB(A)]
Vacuum pump	Integrated, electric BLDC			
Dust filters	Integrated 50µm, field replaceable			
IP Classification	IP54			
Dimensions	264 x 184 x 92			[mm]
	10.39 x 7.24 x 3.62			[inch]
Weight	2.55			[kg]
	5.62			[lb]



Long-stroke, high-payload elevator enables a wide range of palletizing tasks



POWER UP PRODUCTION

- Long-stroke elevator creates 7th axis for leading robot arms to enable a wide range of future-proofed palletizing tasks
- High-payload elevator with minimal deflection ensures precise positioning of boxes – even at high speeds
- Robust design for reliable, long product life under all typical manufacturing conditions
- Integrated safety features with TÜV-certified stop functionality to facilitate collaborative deployment
- Out-of-the-box integration with OnRobot palletizing solution shortens deployment time

TECHNICAL SPECIFICATIONS

General Properties	Minimum	Typical	Maximum	Unit
Payload	0	-	100	[kg]
	0	-	220	[lb]
Height above floor	730	-	1630	[mm]
	28.74	-	64.17	[inch]
Stroke of lift	0	-	900	[mm]
	0	-	35.43	[inch]
Lift speed	0	-	100	[mm]
	0	-	3.39	[inch]
Weight	86			[kg]
	189.6			[lb]
Dimensions [L x W x D]	730 x 325 x 492	-	1630 x 325 x 492	[mm]
	28.74 x 12.8 x 19.37	-	64.17 x 12.8 x 19.37	[inch]
Interfaces / Communication	Modbus			
Storage temperature	0	-	60	[°C]
	32	-	140	[°F]
IP Classification	IP54			



Pallet Station

Off-the-shelf fixture helps with pallet positioning for more reliable palletizing jobs

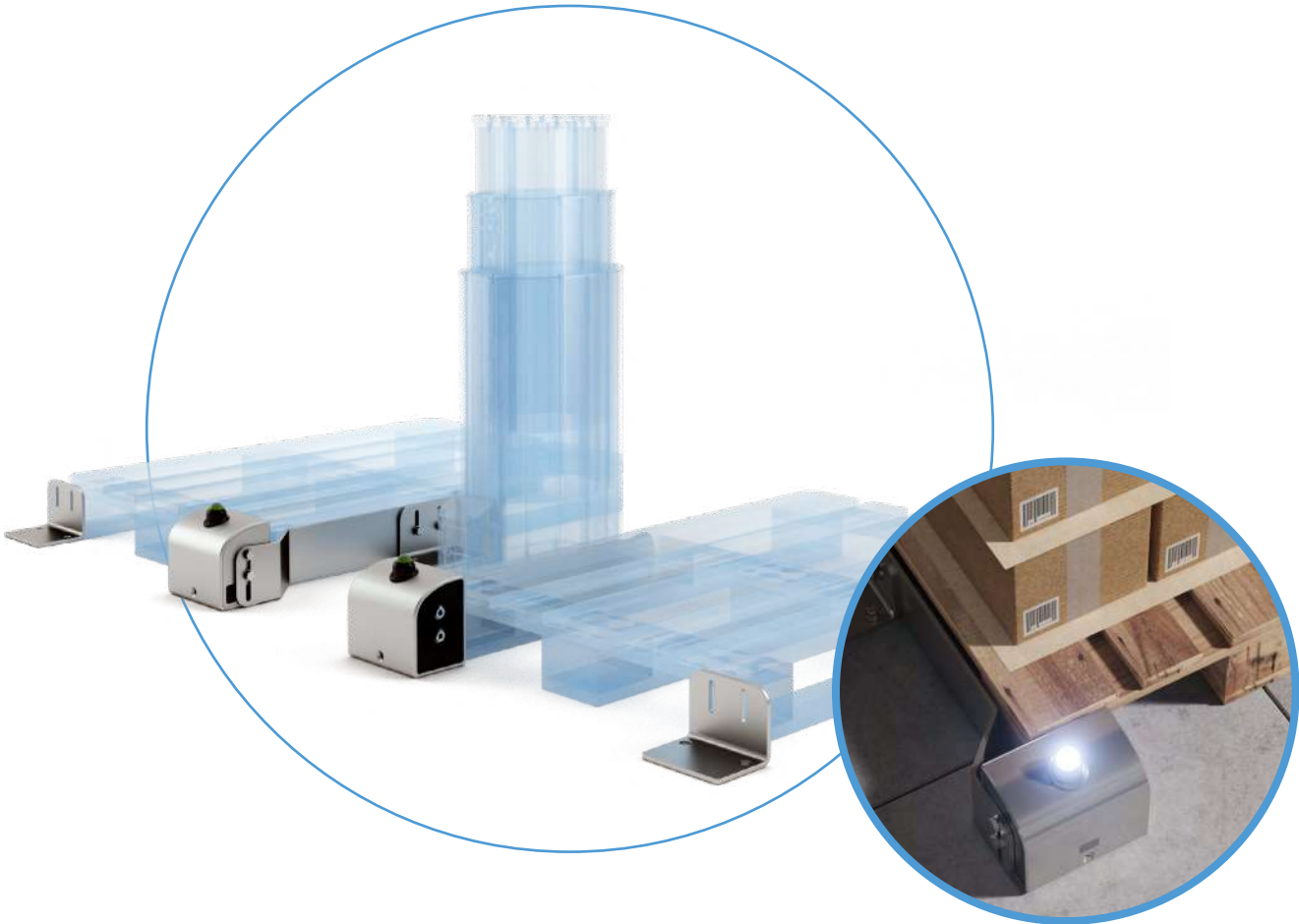

POWER UP PRODUCTION

- Durable, floor-mounted pallet fixture that ensures consistent pallet positioning and can withstand hits from stackers and trucks
- Includes a built-in sensor for detecting pallet presence
- Off-the-shelf fixture saves significant engineering effort and shortens deployment time
- Durable floor mounted pallet fixtures designed to ensure consistent positioning.

TECHNICAL SPECIFICATIONS

General Properties	Minimum	Typical	Maximum	Unit
Sensor activation zone	0	-	6	[mm]
	0	-	0.236	[inch]
Weight	17			[kg]
	34.5			[lb]
Dimensions [L x W x D]	828 x 428.5 x 207.5	-	828 x ∞ x 207.5	[mm]
	32.6 x 16.87 x 8.17	-	32.6 x ∞ x 8.17	[inch]
Pallet sizes	All sizes *			
Interfaces / communication	I/O			
Storage temperature	0	-	60	[°C]
	32	-	140	[°F]
IP Classification	IP54			



POWER UP PRODUCTION

- Complete, easy-to-program, collaborative parallel gripper gets to work fast in a wide range of applications
- Strong parallel gripper is easy to deploy in tight spaces and handles even demanding payload requirements
- Get fast ROI with a single flexible, intelligent, and precise gripper that can be easily customized and adapted for many different tasks
- Ready for use almost anywhere, with IP67 rating for harsh environments and ISO Class 5 certification for cleanroom use

TECHNICAL SPECIFICATIONS

General Properties			Minimum	Typical	Maximum	Unit
Payload Force Fit			-	-	7 [15.5]	kg [lb]
Payload Form Fit			-	-	11 [24.3]	kg [lb]
Total stroke			-	38	-	mm
Grip Width range	External	Fingers inwards	1 [0.039]	-	39 [1.53]	mm [inch]
		Fingers outwards	35 [1.37]	-	73 [2.87]	mm [inch]
	Internal	Fingers inwards	11 [0.43]	-	49 [1.92]	mm [inch]
		Fingers outwards	45 [1.77]	-	83 [3.26]	mm [inch]
Gripping force			20	-	140	N
Gripping speed			16	-	450	mm/s
Gripping repeatability			-	+/-0.1 [+/-0.004]	-	mm [inch]
Hold workpiece if power loss?			Yes			
IP Classification			IP67			
Dimensions [L, W, D]			144 x 90 x 71 [5.67 x 3.54 x 2.79]			mm [inch]
Weight			1.14 [2.4]			kg [lb]



2FG14

Powerful electric parallel gripper



POWER UP PRODUCTION

- Effortlessly handle larger and heavier parts with the powerful 2FG14, boasting double the force and eight times the torque of its predecessor.
- Enhanced torque offers unparalleled flexibility in designing custom fingers, easily adaptable to your unique application requirements.
- Robust design ensures consistent and reliable performance even in demanding industrial settings, offering durability that powers your operations forward.
- Double gripping power for increased productivity across applications, ensuring you get the most out of your robot payload and application.

TECHNICAL SPECIFICATIONS

General Properties		Minimum	Typical	Maximum	Unit	
Payload Force Fit		-	-	14	[kg]	
Payload Form Fit		-	-	20	[kg]	
Total stroke		-	50	-	[mm]	
Grip Width range	External	Fingers inwards	5	-	55	[mm]
		Fingers outwards	55	-	105	[mm]
	Internal	Fingers inwards	17.6	-	67.6	[mm]
		Fingers outwards	67.6	-	117.6	[mm]
Gripping repeatability		-	+/- 0.1	-	[mm]	
Gripping force		40	-	280	[N]	
Gripping force tolerance		-	-	+/-10	[N]	
Gripping speed		16	-	100	[mm/s]	
Gripping time (including brake activation)		-	200	-	[ms]	
Hold workpiece if power loss?		Yes				
IP Classification		IP67				
Dimensions [L, W, D]		155.2 x 115 x 70			[mm]	
Weight		1.45			[kg]	





POWER UP PRODUCTION

- Flexible grippers can be used for a wide range of part sizes and shapes.
- Plug & Produce design reduces deployment time from a day to an hour.
- Easy deployment with out-of-the box grippers reduces programming time by 70%



RG2 TECHNICAL SPECIFICATIONS

General Properties	Minimum	Maximum	Unit
Payload Force Fit	- -	2 4.4	[kg] [lb]
Total stroke (adjustable)	0 0	110 4.33	[mm] [inch]
Gripping force (adjustable)	3	40	[N]
Gripping speed	38	127	[mm/s]
Gripping time	0.06	0.21	[s]
IP Classification	IP54		

RG6 TECHNICAL SPECIFICATIONS

General Properties	Minimum	Maximum	Unit
Payload Force Fit	- -	6 13,2	[kg] [lb]
Total stroke (adjustable)	0 -	160 6.3	[mm] [inch]
Gripping force (adjustable)	25	120	[N]
Gripping speed	51	160	[mm/s]
Gripping time	0.05	0.15	s
IP Classification	54		

RG2-FT

Pick & Collaborate – helping hand with a sense of touch

The world’s first gripper that can detect objects using built-in force/torque and proximity sensors.

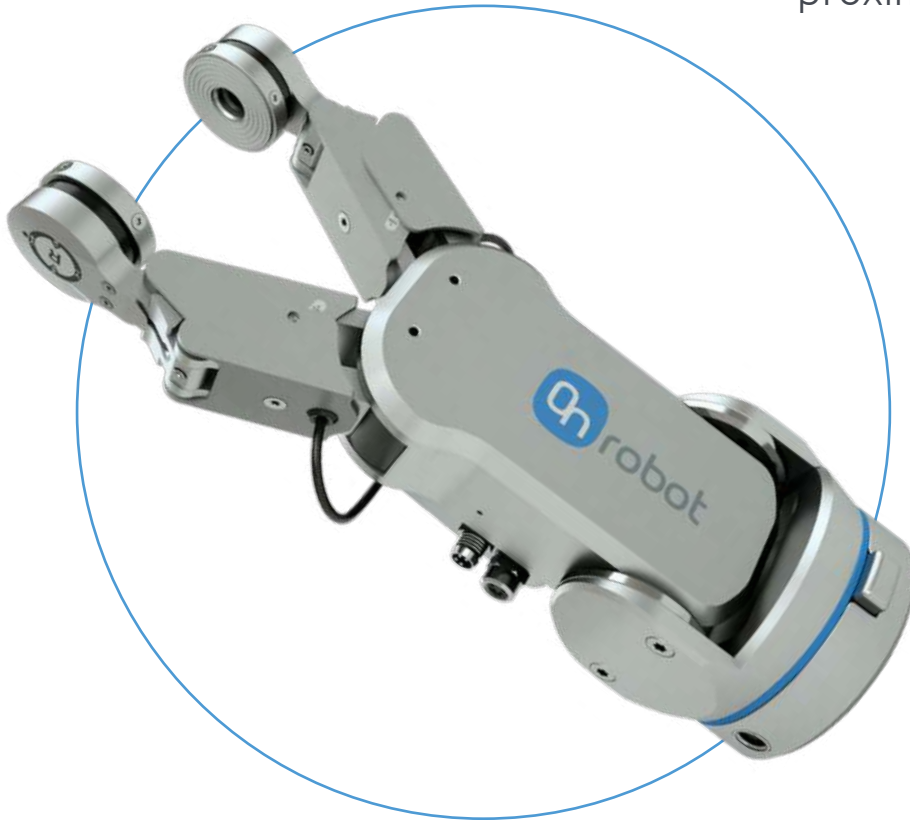

POWER UP PRODUCTION

- Accurate sensing improves production quality by reducing defect rate as much as 60% in delicate Pick & Place processes.
- Easy-to-program sensing allows robot to act like an operator’s third arm, with human-like part hand-offs.
- Ability to automate insertion tasks that weren’t previously possible can reduce operation costs by 40%.

RG2-FT TECHNICAL SPECIFICATIONS

General Properties	Minimum	Maximum	Unit
Payload Force Fit	- -	2 4.4	[kg] [lb]
Total stroke (adjustable)	0 0	100 3.93	[mm] [inch]
IP Classification	IP54		

Force Sensor Properties	Fxy	Fz	Txy	Tz	Units
Nominal capacity (N.C.)	20	40	0.7	0.5	[N] [Nm]
Noise free resolution	0.1	0.4	0.008	0.005	[N] [Nm]





POWER UP PRODUCTION

- Out-of-the-box deployment – plug into the robot arm and configure the gripper to fit the product – provides fast productivity and ROI.
- No external air supply required reduces maintenance costs and speeds deployment.
- Dual gripping functionality enables shorter cycle time.

VG10 TECHNICAL SPECIFICATIONS

General Properties	Minimum	Maximum	Unit
Vacuum	5 % -0.05 1.5	80 % -0.810 24	[Vacuum] [Bar] [inHg]
Air flow	0	12	[NL/min]
Payload	0 0	15 33	[kg] [lb]
Recommended workpiece size	10x10 0.5x0.5	500x500 20x20	[mm] [inch]
Vacuum cups	1	16	[pcs.]
Gripping time	-	0.35	[s]
Releasing time	-	0.20	[s]
Vacuum pump	Integrated, electric BLDC		
Arms	4, adjustable by hand, 2 vacuum channels		
IP Classification	IP54		
Dimensions (folded)	105 x 146 x 146 4.13 x 5.75 x 5.75		[mm] [inch]
Dimensions (unfolded)	105 x 390 x 390 4.13 x 15.35 x 15.35		[mm] [inch]
Weight	1.62 3.57		[kg] [lb]



VGC10

Compact vacuum gripper
for all your needs



POWER UP PRODUCTION

- Flexible electric vacuum gripper with unlimited customization fits all your application needs
- Small, lightweight gripper is perfect for tight spaces but with plenty of power for objects up to 15kg
- No external air supply needed for reduced maintenance costs and faster deployment

VGC10 TECHNICAL SPECIFICATIONS

General Properties	Minimum	Typical	Maximum	Unit
Vacuum	5 % -0.05 1.5	- - -	80 % -0.810 24	[Vacuum] [Bar] [inHg]
Air flow	0		12	[NL/min]
Payload	0	-	15 33	[kg] [lb]
Recommended workpiece size	Unlimited, depends on custom arms			
Vacuum cups	1	-	7	[pcs.]
Gripping time	-	0.35	-	[s]
Releasing time	-	0.20	-	[s]
Vacuum pump	Integrated, electric BLDC			
Arms	Replaceable, customizable			
Dust filters	Integrated 50µm, field replaceable			
IP Classification	IP54			
Dimensions (folded)	101 x 100 x 100 3.97 x 3.94 x 3.94			[mm] [inch]
Weight	0.814 1.79			[kg] [lb]





POWER UP PRODUCTION

- Electric magnetic gripper offers fast out-of-the-box deployment without the complexity and costs of external air supply
- Built-in intelligence with easily adjustable force and part detection ensures reliable handling of a wide range of part sizes and weights
- Fast, compact and customizable gripper to fit all your application needs
- Ensure safe and reliable operation by maintaining grip even after power loss or emergency stop



TECHNICAL SPECIFICATIONS

General Properties	Minimum	Typical	Maximum	Unit
Payload	0.001	-	10	[kg]
	0.002	-	22.046	[lb]
Workpiece size required for full force	Ø 65.4	-	-	[mm]
	Ø 2.574	-	-	[inch]
Magnetism resolution	-	100	-	[steps]
Gripping time (including brake activation)	-	300	-	[ms]
Hold workpiece if power is lost?	Yes			
Storage temperature	0	-	55	[°C]
	32	-	131	[°F]
Motor	Integrated, electric BLDC			
IP Classification	IP67			
Dimensions [Ø, L]	71 x 80.2			[mm]
	2.8 x 3.24			[inch]
Weight	0.8			[kg]
	1.763			[lb]

Gecko Gripper SP1/SP3/SP5



TECHNICAL SPECIFICATIONS

POWER UP PRODUCTION

- Compact, lightweight Gecko Gripper requires no cables, electricity, air, or programming for cost-effective, plug-and-play performance
- Innovative adhesive gripper for flat, smooth, or perforated objects automates tasks that were previously not possible
- No-mark gripping even for shiny surfaces means no cleaning step is required, saving time and improving productivity
- No requirement for external air supply reduces noise and dust, lowers maintenance costs, and speeds deployment

General Properties			Unit
Maximum payload	SP1	1 / 2.2	[kg] / [lb]
	SP3	3 / 6.6	[kg] / [lb]
	SP5	5 / 11	[kg] / [lb]
Preload required	Minimum	SP1: 2.8 SP3: 8.2 SP5: 11.6	[N]
	Medium	SP1: 8.2 SP3: 23.4 SP5: 33	[N]
	Maximum	SP1: 13.3 SP3: 38.6 SP5: 54.4	[N]
Detachment time	100-1000 (dependent on robot speed)		[msec]
Holds workpiece on power loss?	Yes. How long? Potentially days if well centered and undisturbed		
IP Classification	IP42		
Dimensions (HxW)	69 x 71 / 2.7 x 2.8		[mm] / [inch]
Weight	SP1	0.267 / 0.587	[kg] / [lb]
	SP3	0.297 / 0.653	[kg] / [lb]
	SP5	0.318 / 0.7	[kg] / [lb]

Pads general properties	Unit
Material	Proprietary silicone blend
Wear properties	Depends on surface roughness
Change-out interval	~200.000 [cycles]
Cleaning systems	1) OnRobot cleaning station 2) Silicone roller 3) Isopropyl Alcohol and lint-free cloth
Cleaning interval	variable
Recovery	100%





POWER UP PRODUCTION

- Explore new possibilities for food and beverage automation with certified food-grade soft gripper
- Easily handle a wide array of irregular shapes and delicate objects with flexible silicon-molded gripper
- Safely handle fragile and delicate objects for higher production quality and reduced waste
- No external air supply means no dust, no noise, no complexity, and no additional costs

TECHNICAL SPECIFICATIONS

General Properties	Minimum	Typical	Maximum	Unit
Material	Two-component silicone rubber			
Food approval	FDA 21 CFR 177.2600 & EC/EU - 1935/2004			
Operation cycles	2.000.000			[cycles]
Operation temperature	-20 / -4		80 / 176	[C] / [F]
SG-tool attachment mechanism	Quick-lock and Smart-lock			
Weight Base Part	0.77 / 1.69			[kg] / [lb]
SG-a-H / SG-a-S				
Max payload	-	-	2.2 / 1.5 4.85 / 3.3	[kg] [lb]
Work range, Grip dimensions (A)	11 / 0.43	-	75 / 2.95	[mm] / [inch]
Work range, Grip depth (B)	-	38 / 1.496	-	[mm] / [inch]
Soft part (SG-a-S) (C)	-	16 / 0.63	-	[mm] / [inch]
Dimensions (HxØmax)	76x112 / 3 x 4.4			[mm] / [inch]
Weight (smart lock included)	0.168 / 0.37			[kg] / [lb]
SG-b-H				
Max payload	-	-	1.1 / 2.42	[kg] / [lb]
Work range, Grip dimensions (A)	24 / 0.94	-	118 / 4.65	[mm] / [inch]
Work range, Grip depth (B)	-	40 / 1.57	-	[mm] / [inch]
Dimensions (HxØmax)	77x109 / 3.03 x 4.29			[mm] / [inch]
Weight (smart lock included)	0.172 / 0.379			[kg] / [lb]



OnRobot Screwdriver

Smart screwdriving solution
for multiple processes



POWER UP PRODUCTION

- Smart screwdriver easily automates multiple screwdriving processes with no downtime for manual changeovers
- Get the job done right — consistently and faster — with dynamic force control and intelligent error detection
- Expand your collaborative automation possibilities with built-in protective functions
- Get fast and easy deployment with automatic screw-feeding system and OnRobot's easy One System setup for any leading robot

TECHNICAL SPECIFICATIONS

General Properties		Minimum	Typical	Maximum	Unit
Screw size range		M1.6	-	M6	
Torque range		0.15 / 0.11	-	5 / 3.68	[Nm] / [lbft]
Torque accuracy	If torque < 1.33Nm/0.98lbft	-	0.04 / 0.03	-	[Nm] / [lbft]
	If torque > 1.33Nm/0.98lbft	-	3	-	[%]
Output speed		-	-	340	[RPM]
Screw length within full safety		-	-	35 / 1.37	[mm] / [inch]
Shank stroke (screw axis)		-	-	55 / 2.16	[mm] / [inch]
Shank preload (adjustable)		0	10	25	[N]
Safety feature force		35	40	45	[N]
Motor (x2)		Integrated, electric BLDC			
IP Classification		IP54			
Dimensions		308x86x114 12.1x3.4x4.5			[mm] [inch]
Weight		2.5 / 5.51			[kg] / [lb]
Screw presenter sizes		M1.6 ; M2 ; M2.5 ; M3 ; M4 ; M5 ; M6			



Complete surface finishing solution with fast and easy setup reduces complexity



POWER UP PRODUCTION

- Powerful and durable electric sander requires no compressed air, significantly reducing running and maintenance costs
- Cost-effective Grit Changer allows automatic switching between sanding grits without operator intervention for increased efficiency
- Flexible tool can be used on a wide range of part geometries and materials
- Sensing capabilities ensure precise adaptation to surface variations or part misalignment, improves product quality and consistency while reducing scrap
- Eliminates operator fatigue and hazards for easy compliance with local health and safety regulations

TECHNICAL SPECIFICATIONS

General Properties		Minimum	Typical	Maximum	Unit
Pad diameter		-	-	127 [5]	mm [inch]
Pad height		-	-	9.5 [0.37]	mm [inch]
Orbit size		-	-	5 [3/16]	mm [inch]
Rotation speed		1,000	-	10,000	RPM
Ped type (3M: 20353)		Clean Sanding Disc Pad			
Pad media type		Hookit™			
Pad weight		0.1 [0.22]			kg [lb]
Weight		1.2 [2.645]			kg [lb]
IP rating		IP54			
Dimensions (outer)		87 x 123 x 214 [3.42 x 4.84 x 8.42]		mm [inch]	
Operating Conditions		Minimum	Typical	Maximum	Unit
Sanding power		-	150	-	W
Operation voltage	External voltage	-	30	-	V
	External power	-	150	-	W
	Tool connector voltage	-	24	-	V
	Tool connector power	-	2.4	-	W
Operation temperature		0 [32]	-	50 [122]	°C [°F]
Noise level at 10,000 RPM (3,000 RPM)		-	74 [44]	-	[dB]



HEX Force / Torque SENSOR

Touch & Go
– automation made simple
with a sense of touch



POWER UP PRODUCTION

- Flexible sensor extends automation possibilities to processes that weren't previously possible.
- Out-of-the-box integration reduces deployment time for precise insertion tasks from months to days.
- High-accuracy sensor technology provides 95% better quality in insertion and assembly tasks.
- Sensor-based applications speed cycle time by up to 60% to produce more with the same number of employees.
- Easy programming gets even complex polishing tasks up and running in less than a day.

HEX-E QC TECHNICAL SPECIFICATIONS

General Properties	6-Axis Force/Torque Sensor		Unit		
	Fxy	Fz	Txy	Tz	
Nominal Capacity (N.C)	200	200	10	5.5	[N] [Nm]
Single axis deformation at N.C (typical)	± 1.7 ± 0.067	± 0.3 ± 0.011	± 2.5 ± 2.5	± 5 ± 5	[mm] [°] [inch] [°]
Resolution (Noise-free)	0.2	0.8	0.01	0.002	[N] [Nm]
IP Classification	67				
Dimensions	50 x 71 x 93 1.97 x 2.79 x 3.66				[mm] [inch]

HEX-H QC TECHNICAL SPECIFICATIONS

General Properties	6-Axis Force/Torque Sensor		Unit		
	Fxy	Fz	Txy	Tz	
Nominal Capacity (N.C)	200	200	20	13	[N] [Nm]
Single axis deformation at N.C (typical)	± 0.6 ± 0.023	± 0.25 ± 0.009	± 2 ± 2	± 3.5 ± 3.5	[mm] [°] [inch] [°]
Resolution (Noise-free)	0.5	1	0.036	0.008	[N] [Nm]
IP Classification	67				
Dimensions	50 x 71 x 93 1.97 x 2.79 x 3.66				[mm] [inch]



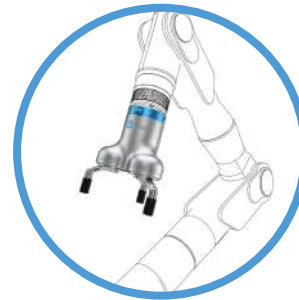

POWER UP PRODUCTION

- Powerful and robust all-electric gripper with accurate centric positioning to enhance quality and output
- Complete out-of-the-box gripper saves engineering effort and reduces deployment time with any leading robot brand
- Handle a wide range of parts using just one gripper, equipped with full gripping control and built-in intelligence
- Built to succeed in challenging manufacturing conditions, especially CNC machine tending with heavy workpieces, ensuring robust performance and reliability

TECHNICAL SPECIFICATIONS

General Properties		Minimum	Typical	Maximum	Unit
Payload Force Fit	Grip	-	-	15 / 33.06	[kg] / [lb]
	Flexible	-	-	10 / 22	[kg] / [lb]
Payload Form Fit		-	-	25 / 55.1	[kg] / [lb]
Grip Diameter*	External	18 / 0.70	-	152 / 5.98	[mm] / [inch]
	Internal	41 / 1.61	-	184 / 7.24	[mm] / [inch]
Finger position resolution		-	0.1 / 0.004	-	[mm] / [inch]
Diameter Repetition accuracy		-	0.1 / 0.004	0.2 / 0.007	[mm] / [inch]
Gripping force	Grip	50	-	450	[N]
	Flexible grip	50	-	300	[N]
Gripping force (adjustable)		1	-	100	[%]
Gripping speed (diameter change)		-	-	45	[mm/s]
Gripping time (including brake activation)		-	500	-	[ms]
Hold workpiece if power loss?		Yes			
IP Classification		IP67			
Dimensions [L, W, Ø]		156 x 168 x 187 / 6.16 x 6.62 x 7.38			[mm] / [inch]
Weight		1.6 / 3.52			[kg] / [lb]



3FG15

Flexible, large-stroke
3-finger gripper



POWER UP PRODUCTION

- Flexible production - large-stroke optimizes CNC lathe-tending for multiple part sizes with a single 3-finger gripper
- Accurate centric positioning drives higher quality, consistency, and output with minimal programming
- Strong, stable grip and 3 contact points makes gripper fast and easy to redeploy for multiple processes
- Accomplish more with customizable fingertips to flexibly grip a wide range of part sizes and shapes

TECHNICAL SPECIFICATIONS

General Properties	Minimum	Typical	Maximum	Unit
Payload Force Fit	-	-	10 / 22	[kg] / [lb]
Payload Form Fit	-	-	15 / 33	[kg] / [lb]
Grip Diameter*	External	4 / 0.16	-	152 / 5.98 [mm] / [inch]
	Internal	35 / 1.38	-	181 / 7.12 [mm] / [inch]
Finger position resolution	-	0.1 / 0.004	-	[mm] / [inch]
Repetition accuracy	-	0.1 / 0.004	0.2 / 0.007	[mm] / [inch]
Gripping force	10	-	240	[N]
Gripping force (adjustable)	3	-	100	[%]
Gripping speed (diameter change)	-	-	125	[mm/s]
Gripping time (including brake activation)	-	500	-	[ms]
Hold workpiece if power loss?	Yes			
IP Classification	IP67			
Dimensions [L, W, Ø]	156 x 158 x 180 / 6.14 x 6.22 x 7.08			[mm] / [inch]
Weight	1.15 / 2.5			[kg] / [lb]



Quick Changer & Dual Quick Changer Bracket

With the Dual Quick Changer, you can now use two tools in one cycle, achieving higher utilization of your robots.

DUAL QUICK CHANGER



Dual Gripper:

- Dual gripper speeds cycle time and can improve productivity by 50% or more.
- Increased productivity offers faster payback, with ROI in as little as 3 months.

Quickly switch between tools to meet changing production needs.

QUICK CHANGER

About OnRobot

OnRobot was founded in 2018 with the mission of breaking down automation barriers and bringing the benefits of robotic automation to manufacturers of all sizes.

Headquartered in Odense, Denmark, and with offices spread across the globe, OnRobot is the world's leading provider of hardware and software solutions for collaborative applications. All offerings are based on the same 'One System, Zero Complexity' platform, delivering a unified experience across all major robot brands.

OnRobot's products and solutions are provided through more than 700 distribution and system integration partners, and used in many different industries. They make it easier and faster to automate tasks such as palletizing, CNC machine tending, packaging, pick and place, sanding, screwdriving, and many more.

Our solutions help small and mid-sized manufacturers optimize their processes and grow their businesses with greater flexibility, higher output and improved quality. We ensure same-day installation of complete robotic solutions, regardless of the robot brand, empowering manufacturers to take control of their automation journey and allowing for swift redeployment when production requirements change.





Contact details:

OnRobot A/S
Teglværksvej 47H
5220 Odense SØ
Denmark
+4553535737
sales@onrobot.com
www.onrobot.com

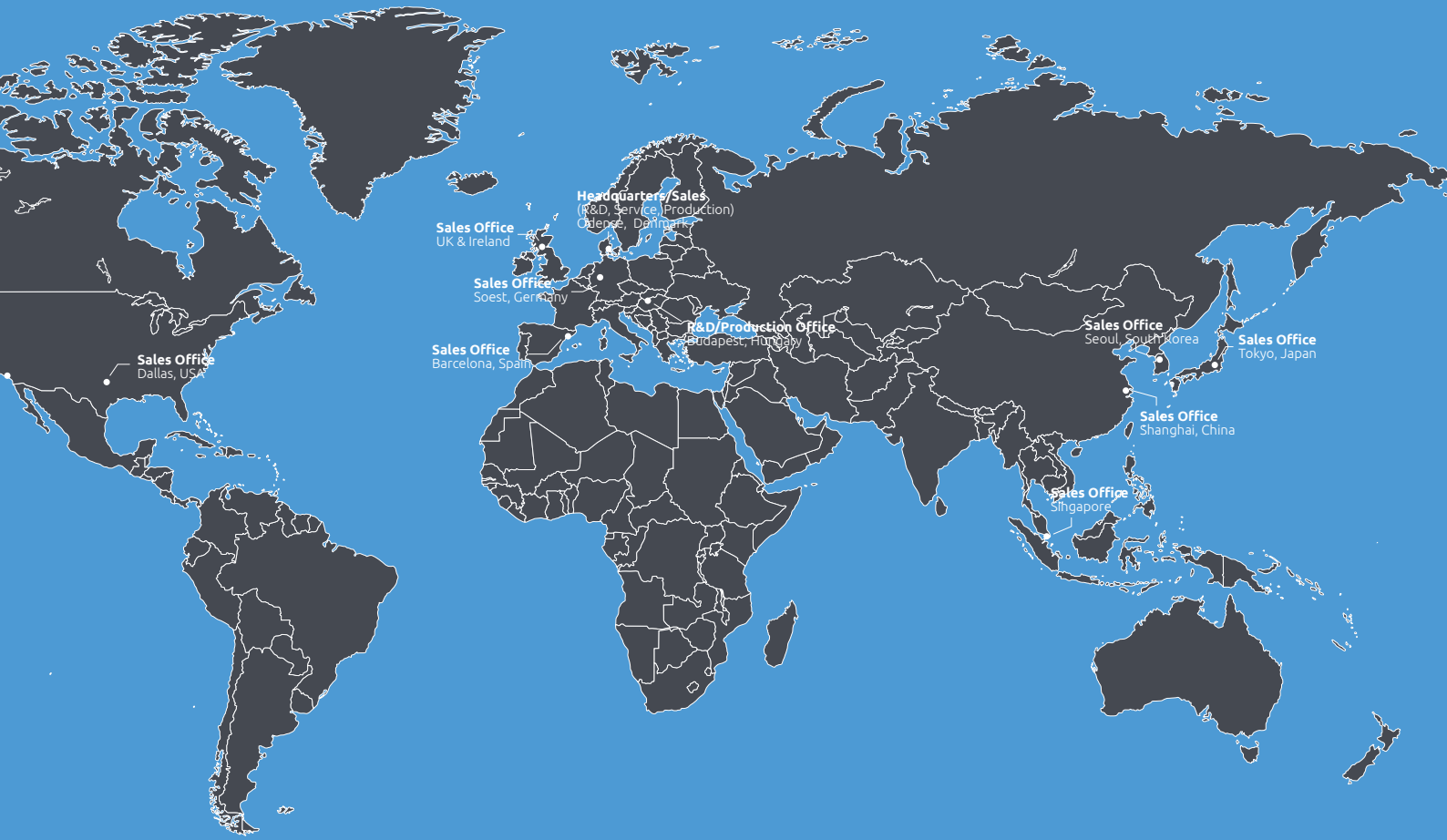

Find an OnRobot partner near you

We sell our products through a global network of valued partners – who have the tools, software, inspiration and training to develop any collaborative application their customers can imagine. Find a partner near you at <https://onrobot.com/en/partners>.